



Index for Touring

A	
AIR CLEANER	73-85
Breather Kits.....	83
Filter.....	73,75,76,77,84,85
Insert.....	82
Scoop.....	76
AXLE	38,49
Spacer.....	49
B	
BELT GUARD	27
BRAKE	
Pad.....	39
Pedal.....	36
Pedal Pad.....	36
Rotor.....	40-41
BREATHER	
Banjo Bolt.....	83
C	
CALIPER	
Front.....	38
Rear.....	37
CAM COVER	24
Trim/Mount.....	24
Kit.....	24
CAPS(Chrome)	87
CLUTCH	
Cable.....	86
Lever.....	112,113
Release Kit.....	30
CYLINDER BASE COVER	26
D	
DASH CONSOLE	91
DASH STASH BOX	91
DERBY COVER	22-23
DISPLAY STAND	47
DIPSTICK	31,72
E	
EMBLEM	93
ENGINE	
Bar.....	56-57
Dress Up.....	26-28
Mount.....	88
EXHAUST	
Baffle.....	66
Fishtail.....	62,63
Heat Shield.....	69
Muffler.....	58-68
Oxygen Sensor Tool.....	68
Plugs.....	68
Wrap.....	68
F	
FAIRING	12-13
FENDER	54,55
Bumper.....	53,54
Ornament.....	54
Trim.....	53,55
Tip.....	52
FILTER	
Air.....	73,75,76,77,84,85
Oil.....	71
FOOTPEG	109

FORK	
Cover.....	45
Dress Up Kit.....	42,95
Slider.....	42,44
Tube/Slider Assembly.....	42
FOOT BOARD	103-109
FORWARD CONTROL	32
FUEL CONSOLE DOOR	91
H	
HANDLEBAR	110-111
Control/Switch.....	112,113,115
Cover.....	114
Switch.....	116,117
Wiring.....	116,117
HANDLEBAR GRIP	114
HEAD BOLT COVER SET	87
HEADLAMP	94-95,96
Fork Cover Set.....	95
HORN	118
I	
IGNITION POINTS COVER	29
INSPECTION TAG HOLDER	105
INSPECTION COVER	23
G	
GAS TANK	92-93
K	
KICKSTAND	70
L	
LEVER	112
LUGGAGE RACK	9,10,11
Hardware.....	10
LOWERING KIT	47
M	
MASTER CYLINDER COVER	32
MANUAL	120
MIRROR	119
MOTOR SHOP SERVICE	1244-1249
MUD FLAP	53
O	
OIL	
Cooler.....	72
Filter.....	71
Dipstick.....	72
Pump.....	71
Pump Cover.....	31
P	
PATCHES (CLOTH)	1307
PRIMARY	
Cover/Trim.....	20,21
Derby.....	22,23
Dress Up Kit.....	20,21
PUSHROD COVER	25
PULLEY COVER	41
R	
ROCKER BOX SET	27,28
Hardware.....	27
S	
SADDLEBAG	3-7,8,9
Hardware.....	5-7,9
Latch.....	7,9
Lid.....	4
Riveting Tool.....	5
SEAT	18
Back Rest.....	19
Handrail.....	18
Mount Kit.....	18
SHIFTER	
Lever.....	33-35
Linkage/Rod.....	33
SHOCK	46
SHOW BIKE BOLT KIT	87
SIDE COVER	8
SISSY BAR/PAD	19
Inserts.....	19
Side Plate.....	19
SNAP CAP	87
SPARK PLUG COVER	26
SPEAKER GRILL	12
SPEEDOMETER	
Bezel.....	85
Cables.....	86
Gauge.....	85
Visor.....	85
SPOTLAMP	96,100
SUSPENSION	46
SWINGARM	89,90
Bushing.....	89,90
Iso Mount.....	88,89
Mounting Kit.....	89,90
Passenger Footboard.....	104
SWITCH	
Handlebar.....	116,117
T	
TAPPET	
Base Cover.....	26
THROTTLE	86
TRANSMISSION	
Cover.....	30,31
Dipstick.....	31
Hardware.....	30,87
Trim.....	31
TOOL KIT	120
TOUR PACK	9
Latch.....	8
Hardware.....	9
Reflector.....	9
TRIPLE TREE	42
Cover.....	42,44
TURN SIGNAL	101,102
W	
WHEEL	49,50,51
WINDSHIELD	12,13,14,15,16,17



49-3505



Watch Our Video!

<http://www.youtube.com/user/TeddCycle>



Deep Saddlebags

- Injection molded for smooth inside and outside surfaces.
- Full set includes left and right sides, lids and bottoms.
- Bottoms have indents for muffler body on the under side with a slight curve down towards the rear.

VT No.	Item	Fits
49-3505	Full Set, Tops & Bottoms	FLT 1993-2013
49-2667	Bottom Set	FLT 1993-2013
49-0723	Liner Kit For Bags	FLT 1993-2013



49-1135

Stretched Saddlebag Bottom Set

- Includes right and left side with black unfinished surface.
- This saddlebag set is a perfect fit with all mounting holes that match stock locations, may re-use stock hardware for a true bolt-on experience. All mount holes are pre-drilled in stock location and pre-fit for the ease of installation.
- The bottoms are 2" deeper in the front than stock and 3" deeper in the rear, which gives these the stretched look.
- Designed for models with dual exhaust.
- Complete hinge, latch, and hardware kit is available separately for Road King riders looking to keep stock bags complete or for converting from leather covered bags. Order lids separately.

VT No.	Item	Fits
49-1135	Black Stretched Bottoms	FLT 2014-up



49-3500

Replica Saddlebags

- Plastic with a primed finish, ready for paint.
- Saddlebags for newer models are injection molded plastic.

VT No.	Item	Fits	Finish
49-3500	Full Set, Tops & Bottoms	FLT 1993-2013	Black
49-2712	Right Bottom	FLT 1993-2013	Black
49-2713	Left Bottom	FLT 1993-2013	Black
49-0535	Right & Left Bottom Set	FLT 1985-1992	Black
49-2714	Right Bottom	FLT 1985-1992	Black
49-2715	Left Bottom	FLT 1985-1992	Black
49-0730	Left/Right	FLT 1993-2013	Black
49-0680	Left/Bottom	FLT 1993-2013	White
49-0681	Right/Bottom	FLT 1993-2013	White

49-0535





Saddlebag Lids

- Lids are plastic with a smooth finish and ready for paint.
- Lids come individually or as a pair.
- Lids for are injection molded black plastic.

49-3503



49-2738



49-2737



49-2725



49-2734
Right Lid



49-2735
Left Lid



49-2730



49-2703 Left Lid



49-2702 Right Lid



49-2700



VT No.	OEM	Item	Finish	Fits	Note
2014-up					
49-2734	90201108	Right Lid	Black	FLT 2014-up	with speaker cutout
49-2735	90201109	Left Lid	Black	FLT 2014-up	with speaker cutout
49-3503		Right & Left Set	Black	FLT 2014-up	with speaker cutout
49-2737	90200411	Right Lid	Black	FLT 2014-up	without speaker cutout
49-2738	90200413	Left Lid	Black	FLT 2014-up	without speaker cutout
49-3504		Right & Left Set	Black	FLT 2014-up	without speaker cutout
1993-2013					
49-0499		Left and Right Set	Primed	FLT, FLHT 1993-2013	with speaker cutout
49-2730	90756-93	Left and Right Lid Set	Primed	FLT, FLHT 1993-2013	
49-2705	90757-93	Left Lid	Primed	FLT 1993-2013	
49-2704	90756-93	Right Lid	Primed	FLT 1993-2013	
1985-1992					
49-2725		Left and Right Lid Kit	Black	FLT 1985-1992	with gasket and hinges
49-2703	90757-85	Left Lid	Black	FLT 1985-1992	plastic, hole for lock
49-2702	90756-85	Right Lid	Black	FLT 1985-1992	plastic, hole for lock
1979-1984					
49-2700	90756-79A	Right Lid	Primed	FLT 1979-1984	fiberglass
49-2701	90757-79A	Left Lid	Primed	FLT 1979-1984	fiberglass
49-0025		Left and Right Lid Kit	Black	FLT 1979-1984	with gasket and hinges

49-2679



49-2680



Saddlebag Tool Tray Set

- Made of ABS plastic. Trays cover the length and width of the saddlebags.
- Easily lift the tray out with one hand when needed.

VT No.	Fits
49-2679	1993-2013
49-2680	2014-up



49-0081 Fits 1993-up FLH
Saddlebag hardware kit with left and right latch assembly set, includes ball head studs.

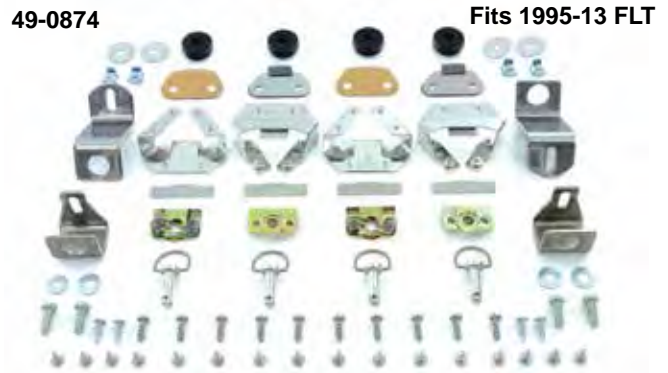

49-0874 Fits 1995-13 FLT



49-0095

Fits 1993-up FLH



49-0900

Fits 1993-up FLT



28-0447



49-0729



49-0886



49-0882



49-0885



49-2506



49-2506

Additional Hardware for Saddlebags

- Replacement application.
- Some parts are also packaged with our mount kits, as indicated.

VT No.	Item	With Mount Kit			Fits
		49-0095	49-1271	49-0081	
49-0874	Mount Hardware Kit 20 pieces	x	x	x	FLT 1995-2013
49-0885	Reinforcing Lid Back Plate Set	x	x	x	FLT 1993-2013
49-0887	Top Straps with screws	x	x	x	FLT 1993-2013
28-0447	Rubber Bumper Set	x	x	x	FLT 1993-2013
49-0856	Gasket Hardware Kit	-	-	-	FLT 1993-2013
15-0581	Saddlebag Gasket, 62" long	x	x	x	FLT 1993-2013
15-0580	Saddlebag Gasket, pair	-	-	-	FLT 1980-1992
49-0886	Lid Wear Plates	-	-	x	FLT 1993-2013
49-0882	Latch Set	-	-	x	FLT 1993-2013
49-0729	Lock and Key Kit	-	x	-	FLT, FLHT 1993-up
49-0723	Liner Kit	-	-	-	FLT 1993-2013
49-1280	Face Plate, Set of 2	-	-	-	FLT 1993-2013
49-1271	Saddlebag Hardware Kit	-	-	-	FLT 1993-2013
49-0900	Saddlebag Hardware Kit	-	-	-	FLT 1993-2013
37-0568	Saddlebag Rivets 3/8"	-	-	-	All Models
37-0566	Saddlebag Rivets 5/16"	-	-	-	All Models
28-0956	Saddlebag Bumper Set	-	-	-	FLT 2014-up
49-0724	Key and Lock Kit	-	-	-	FLT 1993-2013
49-1005	Key and Lock, Black, pair	-	-	-	FLT 1993-2013
49-0081	Hardware Left/Right Latch Assy	-	-	-	FLH 1993-2013
49-0095	Hardware/without Latch set	-	-	-	FLH 1993-2013
49-2506	Hinge Kit	-	-	-	FLT 1979-92
16-1881	Jims Saddlebag Latch Rivet Tool	-	-	-	All

Saddlebag Lock Kit

- Fits 2014-up.
- Includes 4 screws and 4 lock tabs.



Riveting Tool

- Installs rivets in saddlebag top and other fiberglass items.
- Constructed of aluminum.

VT No. 16-0896

2014-up Touring Saddlebag.

VT No.	Item
49-1262	Mount Isolator Set
49-1263	Strike Set
49-1264	Seal Set
49-1265	Tether Set
49-1266	Handle Kit, Chrome
49-1267	Stud Set
49-1268	Hinge Kit
49-1269	Cover Gasket
49-1270	Lock Set



49-2508



49-2508 Installed



49-0791

31-1562



49-0532

Chrome Saddlebag Guard Kit

- Includes chrome rail set (right and left) & mount brackets.
- Brackets are 15% thicker than stock for added support to prevent breakage.

VT No.	Item	Fits
49-2508	Kit	FLHT 1997-2008, FLHR 1997-2008
49-0791	Brackets	FLT 1979-2013
31-1562		Repair Brackets, FLT 1979-2013
49-0532		Bracket, Heavy Duty, FLT 1979-2013
49-1724	Set	Forged Alloy

50-0959



Chrome Saddlebag Trim Rail Kit

- Accents FL saddlebag top covers and offers protection from scratching

VT No.	Fits
50-0959	FLT 1987-up



Forged Alloy Saddlebag Guard Kit Brackets is forged alloy heavy duty construction which is 15% thicker than stock for added support to prevent breakage. Mounts with stock hardware. Fits FLT 1979-2013.

VT No. 49-1724



49-0798

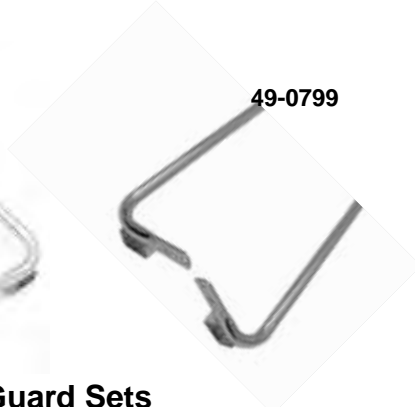

49-0799

Lower Saddlebag Guard Sets

- Left and right saddlebag guards with a chrome finish.

VT No.	Fits
49-0798	FLTR 2004-2008, FLHRS 2004-2008, FLHRX 2006-2008
49-0799	FLTR 1998-2003, FLHT 1993-2013, FLHR 1993-2008

50-0873



50-1518



Saddlebag Guard Eliminator Brackets

- Go from the frame to the lower support bracket and replace the saddlebag guards and upper saddlebag rails.

Chrome	Black	Fits
50-0873	50-1518	FLT 1997-2008

50-1113

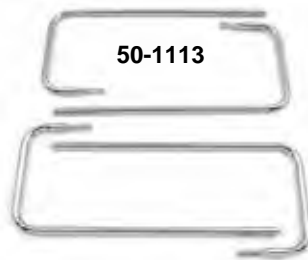

Chrome Saddlebag Rail Set

- Includes four chrome pieces to replace original.

VT No.	Fits
50-1113	FLT 1993-2008



50-1135



50-1136



49-0468

Saddlebag Filler Panels

Chrome	Black	Year
50-1135	50-1136	1993-08, rear
49-0468	49-0469	2009-13, top



Saddlebag Face Plates

• Fit 1993-2013 Touring

Style	Chrome	Black
Plain Winged	42-1099	42-1117
Flame Winged	42-1100	—
Billet Winged	42-0176	42-0179
Ball Milled Winged	42-1104	42-1126
Diamond Cut Winged	—	42-0583
Perforated Winged	—	42-1163
Speed Line	42-1064	—
Contour	42-1130	42-1124
Perforated	42-1111	—
Carbon Fiber	—	42-7103
Smooth with reflector	49-0867	—
Smooth with reflector, Wyatt	49-0892	—
Flame	42-1013	—

Style	Chrome	Black
Louvered	42-1128	—
Deep Cut	42-1129	—
Ball Milled	42-1131	—
Finned	42-0180	—
Swiss Cheese	42-1097	42-1127
Flair	42-1098	—
Chrome Face Plate Kit; includes flame insert	49-0883	—
	42-0365	—



Saddlebag Filler Panels

• Fit 2006-2008 FLHX.

VT No.	Finish
42-1107	Chrome
42-1108	Raw

42-1107



51-0480



49-0873

Chrome Saddlebag Support Set

• Left and right set used when saddlebag trim set are not used to create a cleaner custom appearance.

VT No.	Fits
51-0480	FLT 2009-2013, 90881-09A
49-0873	FLHX, FLTRX, FLT 2009-2013



49-1281

49-1282

42-1162

49-1011

2014-up Saddlebag Hinge Cover Kits.

Chrome	Black	Style
49-1281	49-1282	Edge Cut
49-1315	49-1316	with reflector
42-1162	—	Smooth with one indent
49-1011	49-1012	Smooth with cuts

48-1197

33-0221

Wyatt Gatling Saddlebag Face Plate Insert Set.

VT No.	Fits
48-1197	FLT 1993-2013, flame
33-0221	Reflector Set Only



49-2719
Installed

Wyatt Gatling FLT Contour Side Cover Sets.

- Made of formed FRP plastic, these side covers
- Feature a clean contoured look that flows back to the saddlebags and have more surface area than stock side covers for continuation of your paint scheme.
- These side covers will compliment our stretched saddlebags or stock saddlebags. Fit all FLT, FLHT, FLHR and FLHX models.



Bertha Leather Saddlebags

- Feature full leather construction with fringe and 1/2" chrome spot.
- FLT models feature fiberglass backing and a battery cutout.
- The 1993-up models have a cut out for stock clearance.

VT No.	Fits
49-2719	1997-2008
49-2720	2009-2013
49-1783	Pins
37-0900	Bushing, 1997-2007
37-0901	Bushing, 2008-up



49-0782
Installed

Chrome Touring Luggage Pack Latch Kit

- For touring pack and saddlebags.
- The kit includes catch and spacer plate plus the screws for installation.
- Two sets are required for each tour pack

VT No.	OEM	Fits
49-0554		1995-05 FLT
49-0782	53000252	2006-13 FLT
49-1245		2014 up FLT





37-9136



50-1216



50-0683

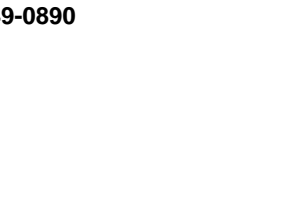

49-0890



49-1006

Hardware for Touring Pack

• Latch kits have parts for a single latch, order in quantity two for complete installation.

VT No.	Years	Fits
37-9136	Latch Set	FLT 1995-06
37-9774	Latch Spacer Set	FLT 1985-2006
37-0352	Latch Kit	FLT 1995-06
50-1216	Hinge Set, chrome	FLT 1988-2013
50-0683	Hinge Set, black	FLT 1988-2013
49-0890	Latch, black	FLT 2006-up
49-0893	Latch, black	FLT 1995-up
49-1006	Lock & Key Kit	FLTR 1992-2013 FLHTC 1992-2013 FLHT 1992-2013 FLHR 1992-2013 FLHX 1992-2013

49-2746



49-2665



15-0583



49-2666

Touring Pack

VT No.	Item
49-2746	Top and Bottom Set
49-2665	Bottom
49-2666	Top
49-2744	Hardware Kit
15-0583	Gasket
49-2747	Trim Kit, Chrome



33-1201

33-1202

33-1203

33-1206

33-1207

Lamp Lenses for Tour Pack

• To be attached to the sides and tail of the Tour Pack.

Side Lens	
33-1201	Red
33-1202	Smoked
33-1203	Clear
Tail Lens	
33-1206	Red
33-1207	Smoked
33-1208	Clear



Aurora Touring Pack Accent Light Kit

VT No.	Item
33-1187	Red Accent light
33-1188	Smoke Accent light
33-1189	Clear Accent light

Saddlebag Set.

VT No.	Item
49-1964	Black Saddlebag Set, FL 1964-1984
49-1967	White Saddlebag Set, FL 1964-1984
49-0730	Touring Saddlebag Set, FL 1993-2013
49-0773	Saddlebag Insert Set, Flame, 1993-2013



50-2021 Contour Fender Racks

- Feature steel construction for use with solo seats for loads of 10 pounds or less.

VT No.	Year	Model	Rack Size
50-2021	1998-up	FLHR	11" x 6"

49-0304



49-0951



49-0832



49-0304 Installed



Old Style Luggage Rack

- Replica of 1940's accessory, contours all rear fenders 1934-up.
- Great for attaching thro-over saddlebags.
- Does not interfere with post mounted buddy or police

VT No.	Finish
49-0304	Polished Replica
49-0951	Chrome Replica
49-0832	Black Replica
37-2096	Chrome Screws, 4 pack, 5/16"-24 oval head slotted



50-1138

50-1526



50-1558



50-1559



50-1512



31-1304



31-1315

Detachable Solo Luggage Rack

- Order hardware separately.

VT No.	Item
50-1138	Rack, OE, FLHT, FLHX, FLHR 1997-2008
50-0723	Rack, Radii, FLT 1996-2008
50-1526	Docking Hardware, OEM 53803-06
50-1558	Rotary Latch Kit, chrome, OEM 12600036
50-1559	Rotary Latch Kit, black, OEM 12600036
31-1304	Bushings (4), wide style, rubber between chrome ends, FL 1996-up
50-1512	Stainless Steel Bushing Set (4), FLT 1996-up
31-1315	Bushings (4), rubber installed between chrome ends, FL 1996-up

49-0832 Installed





50-2074



50-2075

Retro Luggage Rack

- Fits FLHR with solo seat.

VT No.	Year
50-2074	1998-up
50-2075	1989-97



Air Deflectors

- Fit the mid frame section of Touring models below the rider seating area to direct engine heat away
- Does not fit 2001-07 with adjustable rider backrest

VT No.	Year
50-0101	2001-08
50-0304	2009-up



50-1523



50-1185

Chrome Luggage Racks for Tour Paks

VT No.	Style	Fits
50-1523	Standard	All King and Chopped lids.
50-1185	Stealth	FLHR 2008-up King, Chopped, Razor lids



Chrome Streamlined Luggage Rack

- Flows with the long and lean lines of your ride.
- The rails and arched fender support with hidden hardware gives the appearance of a floating rack design.

VT No.	Fits
50-0679	FLHX 2006-08, FLHT 1999-05, FLHR 1999-08



50-0595



50-0596

Chrome Luggage Racks.

VT No.	Fits	Year
50-0595	Side Car	1967-2011
50-0596	Tour Pack	1979-up



50-0595 Installed

Note: Racks are designed for loads of 10 pounds or less!



51-0420

51-0422



42-9999

42-9998

Windshield Deflector Set.

VT No.	Color	Fits
51-0420	Dark Smoke	FLH 1996-2013, FLHX 1996-2013
51-0421	Dark Smoke	FLH 1996-2013, FLHX 1996-2013
51-0422	Black	FLT 2009-up heat protection

Windshield Trim

•Four accent slots, includes stainless steel mounting hardware.

VT No.	Item	Finish
42-9999	1996-2013 FLH, FLHX	Polished
42-9998	1996-2013 FLH, FLHX	Stainless



42-9997



42-9996



Inner Fairing Trim Kit includes complete chrome trim for dressing all gauges, radio faceplate, and speakers, and a gloss black dash fascia. Easy to install with self-adhesive backing. Fits 2014-up FLHX, FLHT.

42-9997 Inner fairing trim kit 61400199

Inner Fairing Trim Kit includes complete chrome trim for dressing all gauges, radio faceplate, and speakers. Easy to install with self-adhesive backing. Fits 2015-UP FLTR.

42-9996 Inner fairing trim kit 61400296



12" Wind Splitter Windshield

• A great look for all Touring models and is shaped for the perfect combination of effective air flow management and style. The sweeping design complements the shape of the fairing and the inner dash panel and adds height over a traditional low-profile wind-deflector in the center where it counts. The shape decreases wind noise and improves the ability to hear the motorcycle's sound system.

VT No.	Fits
51-0425	2015-up FLTR
51-0426	1998-2013 FLTR



50-0010



50-0012



49-0736



49-0737

Chrome Deep Cut Inner Fairing Speaker Grill Set

VT No.	Fits	Type
50-0010	FLT 2000-2013	Deep Cut
50-0012	FLT 2000-2013	Chrome with black skull
50-0736	FLT 2014-up	Chrome with black skull
49-0736	FLT 1996-2013	Chrome
49-0737	FLT 2014-up	Chrome

10" Light Smoke Windshield

VT No.	Fits
51-0448	2014-up FLHX, FLHT
51-0449	1996-2013 FLHX, FLHT



Chrome Fairing Support Bracket Set

• Mounts to fairing with stock hardware and features mounting holes for turn signal relocation if desired. **VT No. 31-0752**



50-1008

Chrome Windshield Deflector Set

• Mount onto fork brackets.

VT No.	Fits
50-1008	FLHT 1985-13, FLT 1985-13, FLHR 1985-13



Chrome Tie Down Brackets

• Mount to the front fork cover and provide a secure point to attach tie downs. **VT No. 31-0025**



42-9960



42-9995

Chrome Lower Fairing Trim

• Perfectly formed to cover cracked or peeling decals.

VT No	Year
42-9960	FLT 1986-95
42-9995	FLT 1996-up



31-0458

Chrome Windshield Mounting Bracket Kit

• Replaces 58069-93 right and left brackets to fit 1987-92 FLHS and 1983-92 FLHTC. Hardware included. **VT No. 31-0458**



31-0438

Chrome Windshield Bracket Kit.

• For use with a chopped style windshield

VT No.	Fits
31-0438	FLHS 1977-up



51-0751



50-0752

Fairing Shell Only

VT No.	Item
51-0751	Shell Only, FLHT 1996-up
50-0752	Shell Only, FLHT, 2014-up
34-0049	Mirror Block Plate Chrome
34-0052	Mirror Block Plate Black



FLT Upper Fair Bracket Repair Kit

• Repairs both left and right upper fairing bracket without removal of upper bracket from motorcycle. Kit includes left and right brackets and hardware. **VT No. 31-0344**



Fairing Support Bar

• The lower fairing support brackets when the engine bar is removed. Includes mounting hardware.

VT No.	Fits
51-0050	2010-up FLHT, FLHR, FLHX
51-0051	2009 FLHT, FLHR
51-0052	2004-08 FLHT, FLHR
51-0053	1998-03 FLHT, FLHR
50-0616	2015-up FLHR Chrome, Fairing Support Kit
50-0617	2015-up FLHR Black, Fairing Support Kit



51-0271



51-0272

National Cycle Wave QR Windshield

• Manufactured from dark tint polycarbonate that features free flowing lines, adjustable rake partitioning and quick release mounting. Order mounting hardware separately.

• 10.50" (26.7cm) 18.00" (45.7cm)

*Note: Will not work with spotlight bar

VT No.	Fits
51-0281	1994-16 FLHR Road King
51-0281	1998-14 FLHRC Road King Classic
51-0281	2004-07 FLHRS Road King Custom
31-9946	Mounting Hardware



51-0274



FLH Replacement Screens

• Fit FLH with fairing 4 or 5 Speed 1960-85.

VT No.	Type
51-0271	Clear 18"
51-0272	Tint 18"
51-0274	Tint 7"



51-0417

FLHR Replacement Polycarbonate Shield

• Features pre-drilled mounting holes for use with stock mounting hardware and is 33% thicker than original windshield Available 13 3/4" tall dark tint. Fits 1994-up FLHR.

VT No.	Height	Color
51-0417	13 3/4"	Dark Tint



Clear Batwing Fairing Windshield

VT No.	OEM	Color	Fits
51-0423	57400227	Clear 10"	2014-up FLHT, FLHX
51-0424	58301-96	Clear 10"	1996-2013 FLHT, FLHX



51-0302

Heavy Duty Windshields

• By National Cycle are wide frame windshields for bikes with widely spaced forks.

VT No.	Tint	Height Range	Fits
51-0242	Light	20" to 21½"	FLHS 1993-up
51-0302	Light	14½" to 15¾"	FLH 1977-1993



1980-up FLT Headlamp & Spotlamp Kit

• Includes chrome ABS headlamp housing, 7" round lamp unit and complete spotlamp kit and turn signals.

VT No.	Item
33-0540	Kit
51-0242	Windshield
31-0438	Bracket for Shield
33-2036	Spotlamp Kit



49-0826



49-0819

Air Duct Bezel.

VT No.	Finish	Years
49-0826	Chrome	2014-up Note: Tear off tape installation
49-0819	Black	2014-up Note: Tear off tap installation
49-0802	Chrome	2014-up
49-0803	Black	2014-up



50-0278

Bracket Set.

VT No.	Type
50-0278	Fairing, Zinc Plated
50-0279	Fairing Batwing Style, Black



51-0328



51-0329



51-0304



51-0305



51-0327



51-0350

Replacement Windshield Screen

• For models with fairings, height and tint as noted.

VT No.	Style	Height	Fits
51-0328	Tinted	14"	FLT 1996-2009
51-0329	Smoked	10"	FLT 1996-2009
51-0304	Clear	12"	FLHT 1986-1995
51-0305	Tinted	6"	FLHT 1986-1995
51-0327	Clear	Stock	FLHT 1996-2009
51-0350	Clear	Stock	FLHR 1997-2007



Replacement Windshield Window

• Fit National windshields.

VT No.	Fits
51-0311	FLHS 1993-up Clear
51-0308	Blue
51-0309	Black



Chrome FLST Windshield Bracket Kit

• Replaces OEM 57951-92 for 1986-up FLST, 1987-up FLSTF and 1988-up FXSTS.
VT No. 31-0437



V-Stream Series Windscreens

For FLHT 1996-13, FLHX 1996-13

51-0400	Clear	17"
51-0401	Clear	14"
51-0402	Dark	10¾"
51-0404	Light	10¾"
51-0403	Dark	7¼"

For FLTR 1998-2013

51-0405	Clear	18"
51-0406	Clear	15¼"
51-0407	Dark	9¼"
51-0408	Clear	9¼"

For FLT 1989-1996

51-0411	Clear	15¾"
---------	-------	------

For FLHT 2014-up Electra Glide/Tri Glide and FLHX (Street Glide)

51-0413	Light Tint	9.6"
51-0414	Light Tint	7.6"
51-0415	Dark Tint	7.6"



51-0400



51-0401



51-0404



51-0402



51-0403

The typical airflow pattern of the wake from most windscreens is called a van Karman vortex. At speeds of 50-90 mph, the air swirls off the windscreen in an approximate 90-degree segment of rotation, hits the bottom of the rider's neck on the way up, and curves off the shoulder at approximately 45 degrees.

The patented "V" shape is so quiet because it pushes this vortex out and away from the side of the rider's head. The rider's helmet then resides in still air, and the passenger's environment is greatly improved as well.

Reduced wind noise... less turbulence... superior strength... perfect style. The VStream revolution is here!



51-0405



51-0407



51-0408



51-0411

National Cycle Wave Windscreens offer riders a custom look for baggers. Wave windscreens are Quantum Hardcoated polycarbonate for unbeatable scratch resistance and impact strength. Available in clear, light tint and dark tint.

Wave Series Windscreen.

For FLT 1996-2013, FLHX 1996-2013

VT No.	Tint	Height
51-0450	Dark	5¼"
51-0452	Light	7¾"
51-0454	Clear	10"

For FLTR 1998-2013

51-0451	Dark	5¼"
51-0453	Light	7¾"
51-0455	Clear	10"



51-0450



51-0452



51-0454



51-0451



51-0453



51-0455



51-0351

Switchblade Removable Windshield

- Allows installation or removal in four seconds without tools.
- Available in three sizes for three styles of riding and features 4.0 mm Lexan Polycarbonate with quantum coating in either clean or tint.
- Also features a key lock for "lock solid" mounting. Order mounting system separately.



51-0356



51-0361



31-9946



SwitchBlade® Quick-Release Windshields Applications

HARLEY-DAVIDSON®					
Model Name	Year	Mount Kit	2-up Clear	Chopped Clear	Chopped Tint
FLH MODELS					
(With/Without Light Bar Installed)					
FLHR Road King	1994-16	31-9946	51-0351	51-0356	51-0361
FLHRC Road King Classic	1996-13	31-9946	51-0351	51-0356	51-0361
FLHRS Road King Custom	2004-07	31-9946	51-0351	51-0356	51-0361



51-0286



51-0447



51-0284



51-0285



51-0447 Installed

National Cycle Spartan Quick Release Windshield

- Features a full size quantum clear hand coated polycarbonate windshield, quick release hardware and a black powder coated mounting frame.
- Available in 16¼" and 18½" heights. Height is measured from head lamp cutout to top of shield.

VT No.	Height	Fits	Mt Hardware
51-0284	16¼"	1986-up FLST	31-9939
51-0285	16¼"	2006-up FXD	31-9947
51-0286	18½"	1986-up FLST	31-9939*
51-0287	18½"	2006-up FXD	31-9938

*Note: When installing shield with spotlight bar use 31-9938 kit

Screens for Windshields

- Dark Smoke Tint
- Fit 1996-up
- Batwing Style

VT No.	OEM	Fits	Height	Style
51-0440	57185-05	1996-13 FLHT, FLHX	7"	Deflector
51-0441	57400205	2014-up FLHT, FLHX	7"	Splitter
51-0442	57400243	2014-up FLHT, FLHX	5"	Deflector
51-0443	57400091	1996-13 FLHT, FLHX	4.5"	Splitter
51-0444	57400204	2014-up FLHT, FLHX	4.5"	Splitter
51-0445	58207-04	1996-13 FLHT, FLHX	4"	Splitter
51-0446	57400229	2014-up FLHT, FLHX	7"	Deflector
51-0447	57164-10	1996-13 FLHT, FLHX	7"	Deflector



47-0885



47-0886



47-0835

Wyatt Gatling Saddle Solo Seat

• Frame mounted solo seat has Naugahyde covering.

VT No.	Fits
47-0885	1996-03 FLT
47-0886	1996-03 FLHR
47-0835	2008-14 FLT, Wyatt Gatling
31-1641	Back Rest Hardware



Black Frame Cover

• Installed between the solo seat and the frame.

VT No.	Fits
42-0707	FLT 1997-up

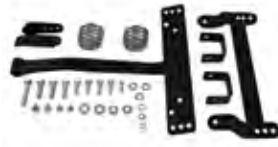

31-9052



31-9052



42-0708

Solo Seat Mount Kits

- Include "Tee" bracket, 2" springs and strut bars for rigid mounting.
- VT No 32-9052 utilizes a center spacer for spring. Kits accept standard size police solos such as VT 47-0226. Bracket. VT No. 31-0177 required to mount buddy seats on these kits which is not included

VT No.	Year	Item
31-9052	1997-07	Kit
42-0708	1997-07	Black Cover



31-0611



31-0943

Chrome Seat Handrails

• Fit behind driver seat area and mount as stock.

VT No.	Fits
31-0611	FLT 1999-2005
31-0943	FLT 2009-up Except FLHTCU & TG



47-0835 Installed



Passenger Pillion Pad.

VT No.	Item
31-9901	Driver Backrest Mounting Kit
31-9902	Driver Backrest Mounting Kit
47-0004	Driver Back rest
47-0005	Passenger Pillion Pad
47-0006	Passenger Pillion Pad

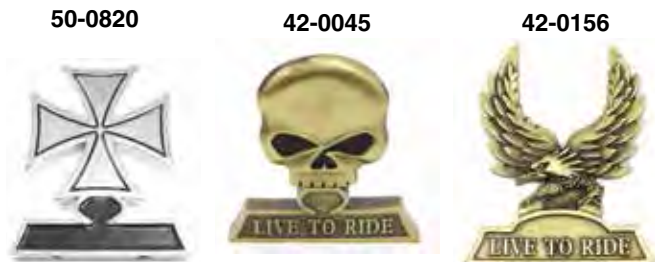

Sissy Bar Inserts

- Featuring brass and chrome finishes as noted.
- Inserts mount with screws to cross bar.

VT No.	Style
50-0820	Chrome Maltese
42-0045	Brass Skull "Live to Ride"
42-0156	Brass Eagle "Live to Ride"



Chrome Sissy Bar Luggage Rack

- Uniquely designed for easy installation

VT No.	Fits
50-1011	Custom application for 16" sissy bars



Flatlander Mini Seat Pad Back Rest

- Measures 5½" wide x 3" tall x 1½" thick.

VT No. Fits

47-0753 All models with a short sissy bar



Pillow Passenger Pad

- 13" tall and fits stock seat rails on 1977-85 FLH-FLT-FLHT.
- Available in pillow style Naugahyde to match factory style seats.
- Includes bushings and washers.

VT No. 47-8654

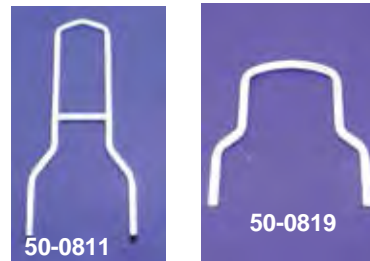

Side Bar Side Strap and Backs.

Order top and straps separately.

Fitment	16" Back	11" Back	Sissy Bar Handrail	Width
1997-08 FLHR	50-0811	50-0815	50-0819	8¾"
2009-up FLHR	50-0811	50-0815	50-0819	8¾"



Sissy Bar Side Plates

- Use with 8¾" outside width sissy bar uprights

VT No. Fits

50-1557	FLHR, FLTR, FLHX 2009-up, non-detachable
50-1556	FLHR, FLTR, FLHX 1997-2008, non-detachable
50-0029	4 Point Docking Hardware
50-0030	2 Point Docking Hardware
50-0031	Standard Sissy Bar
50-0032	Short Detachable Sissy Bar



43-0534



43-0531



43-0527



43-0514



43-0515



Chrome Engine Dress Up Kits

• Include chrome parts and hardware for installation.

VT No.	Fits
43-0534	FLT 2001-2006 TC-88
42-0692	FLT 1999-2000 TC-88
43-0528	FLT 1994-1998
43-0527	FLT 1993
43-0531	FLT 1992
43-0518	FLT 1989-1991
43-0515	FLT 1987-1988
43-0514	FLT 1985-1986



Lower Only

9859-20	1989-99	FLT	Chrome
9928-20	1989-99	FLT	Allen
9928-20-P	1989-99	FLT	Polished Allen

Trans to Motor Mount FLT



8916-17T

Chrome Primary Cover Screw Kits

• Include all necessary screws and washers.

VT No.	Head Style	Fits
9959-38	Knurled	FLT 1999-2006
9959-38T	Knurled	FLT 1999-2006
8916-17	Allen	FLT 1985-1999
8916-17T	Allen	FLT 1985-1999

Chrome Allen Screw Kit

• Connects motor mounts, front, top and rear to frame on models listed below. Knurled.

VT No.	Fits
37-9185	1987-90 FLT
37-9186	1991-up FLT



43-0883



43-0276



43-0560



43-0232



43-0209



43-0374



43-0294



42-0272



43-0267



Chrome Outer Primary Cover Only

- With machined components installed.
- Order screws, gaskets, and other hardware separately.

VT No.	Fits
43-0883	FLT 2007-up
43-0276	FLT 1999-2006
43-0560	FLT 1994-1998
43-0232	FLT 1989-1993
43-0209	FLT 1985-1988
43-0374	FLT 2007-up, Flat Black Finish



Replica Chrome 5-Speed Outer Primary Cover

- Accepts a 5-hole derby cover.

VT No.	Fits
43-0248	FLT 1999-2006

Chrome Outer Primary Cover Kits with or without derby covers

- Die cast stock replacement outer cover kit comes with chrome primary cover, chrome allen screws, outer cover starter bearing derby, inspection and outer cover gaskets included.

Without Derby	With Derby	Fits
43-0341		FLT 1989-1993
43-0249		FLT 1999-2006
43-0782	43-0294	FLT 2007-up
	43-0265	FLT 1994-2006
43-0341	43-0267	FLT 1989-1993
43-0340	43-0272	FLT 1985-1988



Primary Derby Cover

TOURING



42-0036



42-0108



42-0991



42-6070



42-0958



42-0579



42-0107



42-9944



42-0747



42-0470



42-0471



42-1073



42-1086



42-1087



42-1118



42-1090



42-0616



42-0605



42-0531



42-9965



42-0102



42-0632



42-0181



42-1257



42-1258



42-1061



42-0558



42-0091



42-0131



42-0580



42-0578



42-0975



42-6026



42-1120



42-0120



Primary Derby Covers

- Fit FLT 1979-1998 and FLT 1999-up respectively.
- Order screw kits and gaskets separately.

Style	3-Hole	5-Hole
V-Tech	42-0036	
3-D Spinner	42-0108	
Maltese Type	42-0991	
Red Baron	42-0990	
Iron Cross	42-0975	
Iron Cross Billet	42-6070	42-6025
Maltese	42-0958	42-0959
Cross		42-6026
Cross Type	42-0579	
Eagle Spirit Chrome Inlay	42-0107	42-0950
Eagle Spirit Gold Inlay	42-9944	42-0849
Chrome Flame	42-0747	42-0922
Chrome Raised Flame	42-0470	42-0466
Black Raised Flame	42-0471	42-0467
Lady Luck	42-1073	42-1074
Chrome Ball Milled	42-1086	42-1088
Chrome Contour	42-1087	42-1091
Black Contour	42-1118	
Chrome Perforated	42-1090	42-1089
Black Perforated		42-1120
V-Twin Ventilated	42-0616	
Smooth Ring	42-7102	42-0120
Smooth Flat Chrome		42-0124
Smooth Dome	42-0605	42-0129
Early Smooth Style	42-0531	
Early Bird Style	42-9965	
Polished Finned	42-0102	
Black Finned	42-0632	
Bad Skull Chrome on Black	42-0181	42-1252
Bad Skull Chrome on Chrome	42-1257	42-1253
Bad Skull Black on Chrome	42-1258	42-1254
Domed Black Skull	42-7101	42-7100
Black Mesh Skull	42-1061	42-1062
Evil Skull Chrome on Black	42-0558	42-0559
Evil Skull Chrome on Chrome	42-0091	42-0092
Raised Skull Black on Chrome	42-0131	42-0132
Big Skull Chrome on Black	42-0580	42-1081
Bonehead Chrome	42-0578	42-1057
Black Ball Milled Cover		42-1140
Grooved, Chrome	42-1142	42-1141
Grooved, Black	42-1150	
Grooved, Chrome		42-1144
Grooved, Black		42-1145
Style	2-Hole	
Grooved, Vertical, Chrome	42-1146	
Grooved, Vertical, Black	42-1147	
Grooved, Horizontal, Chrome	42-1148	
Grooved, Horizontal, Black	42-1166	



42-1145



42-1147



42-1166



42-0124



42-0817



42-1226



42-1225

Chrome Derby and Inspection Oval Sets

- For 1970-1998 primary covers.

VT No.	Style	Fits
42-0817	Flame	FLT 1970-1998
42-1226	V-Twin Vented	FLT 1970-1998
42-1225	Billet Vented	FLT 1970-1998



42-0740



42-0944

Chrome Primary Inspection Covers

VT No.	Style	Fits
42-0740	Smooth	FLT 1985-up
42-0944	Flame	FLT 1985-1994



42-0111



42-0118



42-0111
Installed

Chrome Nose Cone Cam Trim

VT No.	Fits
42-0118	FLT 1993-1998
10-0286	FLT 1993-1999
42-0111	FLT 1979-1992



10-0297
Installed



10-1298



10-0088



10-0297

Nose Cone Gear Covers fit 1973-99 Big Twin models. Bushings installed. Seal included.

VT No.	Years	Finish	Item
10-1298	1973-93	Black	Cover
10-0088	1973-92	Polished	Cover
10-0297	1993-99	Black	Cover



42-0702



10-0813



10-0040



10-0080



42-1054

Cam Cover or Trim

- Fit over stock cam cases on Big Twins.

No need to remove the cam case or disturb the cam or gears. Covers are held in place by existing screws.

For Big Twin models feature installed bushings and include seals. *Note: 10-0040 comes with mounting screws.

VT No.	Fits	Item
42-0702	FLT 2001-up, chrome	Trim
10-0813	FLT 1999-2000 TC-88, chrome	Trim
10-0080	FLT 1993-1999, chrome	Cover
10-0040*	FLT 1973-1992, chrome	Cover
10-0111	FLT 1973-1992, chrome	Cover
42-1054	FLT 2001-up, black	Trim
10-0813	FLT 1999-2000 TC-88, chrome	Cover



9946-20



9819-12



8761-7



7402-7

Cam Cover Mount Kits

VT No.	Head Style	Fits
9946-20	Stock	FLT 1999-up
9946-20-P	Polished	FLT 1999-up
9819-12	Allen	FLT 1993-1999
8761-7	Allen	FLT 1984-1992
9305-7	Stock	FLT 1979-1992
7402-7	Acorn	FLT 1979-1992



11-0938
Installed

11-0938



11-0376



11-0909



Chrome Pushrod Cover Kits

- Include tubes and all seals for complete installation.

VT No.	Style	Fits
11-0938	Stock	FLT 1999-up
11-0376	Black	FLT 1999-up
11-0943	Billet	FLT 1999-up
11-0909	Stock	FLT 1984-1998
11-0947	Billet	FLT 1984-1998
11-0945	Curved	FLT 1984-1998



Chrome Billet Pushrod Cover & Tappet Base Kit

VT No.	Fits
42-0937	FLT 1999-up



Chrome Pushrod and Tappet Trim Set

- Covers as a complete dress up kit for Big Twin models.

VT No.	Fits
42-0903	FLT 1984-1998



37-9078



37-9079



11-1073

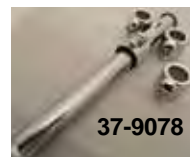

37-9078



Pushrod Cover Cup Sets

- Feature die-cast construction in chrome or gold, set of four.

VT No.	Finish	Style	Fits
37-9078	Chrome	Skull	FLT 1979-up
37-9079	Gold	Skull	FLT 1979-up
11-1073	Brass	Hex	FL 1941-1984



10-0811



10-0815

Chrome Tappet Block Set

• Accepts standard sized tappet assembly in varied styles as noted. Sets include gaskets, *except for 11-9506. Hardware sold separately..

VT No.	Style	Fits
10-0811	Stock	FLT 1999-up
10-0815	Billet	FLT 1999-up
11-9506*	Stock	FLT 1984-1998



42-0437



42-0437 Installed



42-0458

Chrome Tappet Cover Trim Set

• Fits over stock blocks. Each cover has a slot which allows it to be installed without removing pushrods.

VT No.	Type	Fits
42-0437	Steel	FLT 1984-1998
42-0458	Die Cast	FLT 1984-1998



42-0929

Chrome Head and Spark Plug Cover

• Held in place by rubber inserts which are supplied in kit.

VT No.	Fits
42-0929	FLT 1986-1990

Hardware for Tappet Blocks

• For the installation of our tappet block sets.

VT No.	Style	Fits
9942-16	Chrome Allen	FLT 1999-up
7628-8	Chrome Acorn	FLT 1979-1998
8726-8	Chrome Allen	FLT 1979-1998
8708-8	Chrome Stock	FLT 1979-1998
8710-8	Black Stock	FLT 1979-1998
15-1542	Gasket for 11-9506	FLT 1979-1998



42-1175

Chrome Left Side Cylinder Base Cover

• Bolts to engine center stud for secure installation

VT No.	Fits
42-1175	FLT 1999-2006



42-0746

Chrome Big Twin Engine Case Trim

• Mounts to center case stud.

VT No.	Fits
42-0746	FLT 1984-1998



11-2700



11-2701



15-1502

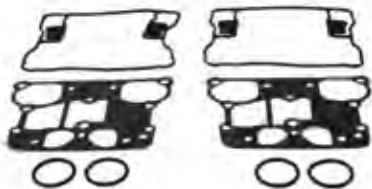

15-1503

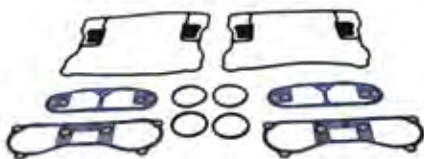

16-1673



Chrome Rocker Box Set

- Includes two upper and two lower for two heads.
- Machined internally for rocker supports.

VT No.	Item	Fits
11-2700	Rocker Box Set	FLT 1999-up
11-2701	Rocker Box Set	FLT 1984-1998
Gaskets and Tool to Match		
15-1502	Gasket	FLT 1999-up
15-1503	Gasket	FLT 1984-1998
16-1673	Wrench Tool	FLT 1984-1998

42-0787



42-0754



Chrome Rocker Box Cover Set

- Precision die cast and machined. The six piece set includes all necessary gaskets for installation for both heads.

VT No.	Fits
42-0787	FLT 1992-1999
42-0754	FLT 1984-1991

37-0585



11-0621



8868-16

Hardware for Rocker Box Set

- Screw kits and cover kits are chrome finished. 37-0820 includes sealing washer with built in o-ring for position seal.

VT No.	Item	Fits
37-0585	Grooved Screw Cover Set	FLT 1999-up
37-0043	Allen Rocker Box Screw Set	FLT 1999-up
8868-16	Acorn Rocker Box Screw Set	FLT 1984-1998
8931-16	Allen Rocker Box Screw Set	FLT 1984-1998
37-0820	Rocker Box Collar and Screw Kit	FLT 1984-1998
15-0663	Red Fiber Washer Seal, 50 Pack	FLT 1984-1998
15-0221	Valve Cover Gasket	FLT 1984-1998
11-0621	Lower Cover Screw Set	FLT 1984-1998
2078-18	Lower Cover Screw Set	FLT 1984-1998



27-0941 Installed

27-0945



27-0941



Chrome Lower Rear Belt Guard

- Belt drive models with 70 tooth rear pulley. ***Note:** 27-1727 covers the existing plastic original lower belt guard.

VT No.	Fits
27-0941	FLT 2009-up
27-0945	FLT 1993-2001
27-1727*	FLT 1997-2008



11-0352



11-0354



11-0946



11-0948

Chrome Rocker Box Sets

- Includes 2 upper covers and 2 lower housings.

VT No.	Item	Fits
11-0946	Top Covers and Lower Housings	FLT 1999-up
11-0948	Top Covers Only	FLT 1999-up

Top Rocker Box Sets from Radii

VT No.	Style	Fits
11-0352	Smooth	FLT 1999-up
11-0354	Contoured	FLT 1999-up



37-8799



37-9131



2024-4



2262-4



42-1092



37-8897

Head Bolt Cover Sets

- Include four covers to conceal head bolts.

VT No.	Style	Fits
37-8799	Chrome Cylinder	FLT 1986-1998
37-9131	Chrome Grooved Cylinder	FLT 1986-1998
2024-4	Hex Chrome Dome	FLT 1986-1998
2262-4	Chrome Spike	FLT 1986-1998
42-1092	Solid Brass	FLT 1984-1998
37-8897	Chrome Dome	FLT 1984-1985



37-9131

Chrome Top Rocker Box Cover & D-Ring Set

- Order gaskets and screws separately.

Chrome	Black	Year
43-9178	43-0379	1984-91
43-0377	43-0378	1992-99



Ignition Points Covers

- 2-hole covers fit FLT 1979-1998.
- 5-hole covers fit FLT 1999-up.

Style	2-Hole	5-Hole
Black Mesh Skull	42-0464	42-0461
Black Mesh Flame	42-0465	42-0462
Chrome Flame	42-0748	42-0969
Chrome Eagle Spirit	42-0106	42-0889
Gold Eagle Spirit	42-0088	42-0836
Chrome Red Baron	42-0177	42-0178
V Tech	42-0035	
Domed	42-0299	42-0119
Flat	42-0662	-
Skull	42-1058	42-1059
Skull	42-1078	42-1079
Flame	42-0065	
Smooth	42-0155	42-0125
Maltese	42-0960	42-0961
Maltese		42-0044
Raised Iron Cross	42-6100	42-6055
Skull Face	42-0081	42-0075
Black Skull	42-0560	42-0562
Skull	-	42-1082
Skull	42-1176	42-1178
Skull		42-1259
Skull Black		42-1260
Black Domed	42-1116	
Black Perforated	42-1125	42-1119
Black Flame	42-1122	
Black Ball Milled		42-1123
Chrome Perforated		42-1093
Contour		42-1094
Chrome Ball Milled	42-1095	42-1096
Skull Design	42-0581	
Chrome Flame	42-0474	42-0472
Black Flame	42-0475	42-0473
Hidden Screws	42-0956	42-0957
Iron Cross Spinner	42-0162	

Hardware for Points Covers

- Screw kits for points covers with head styles as noted

VT No.	Style	Fits
8765-2	Allen	FLT 1979-1998
8402-2	Acorn	FLT 1979-1998

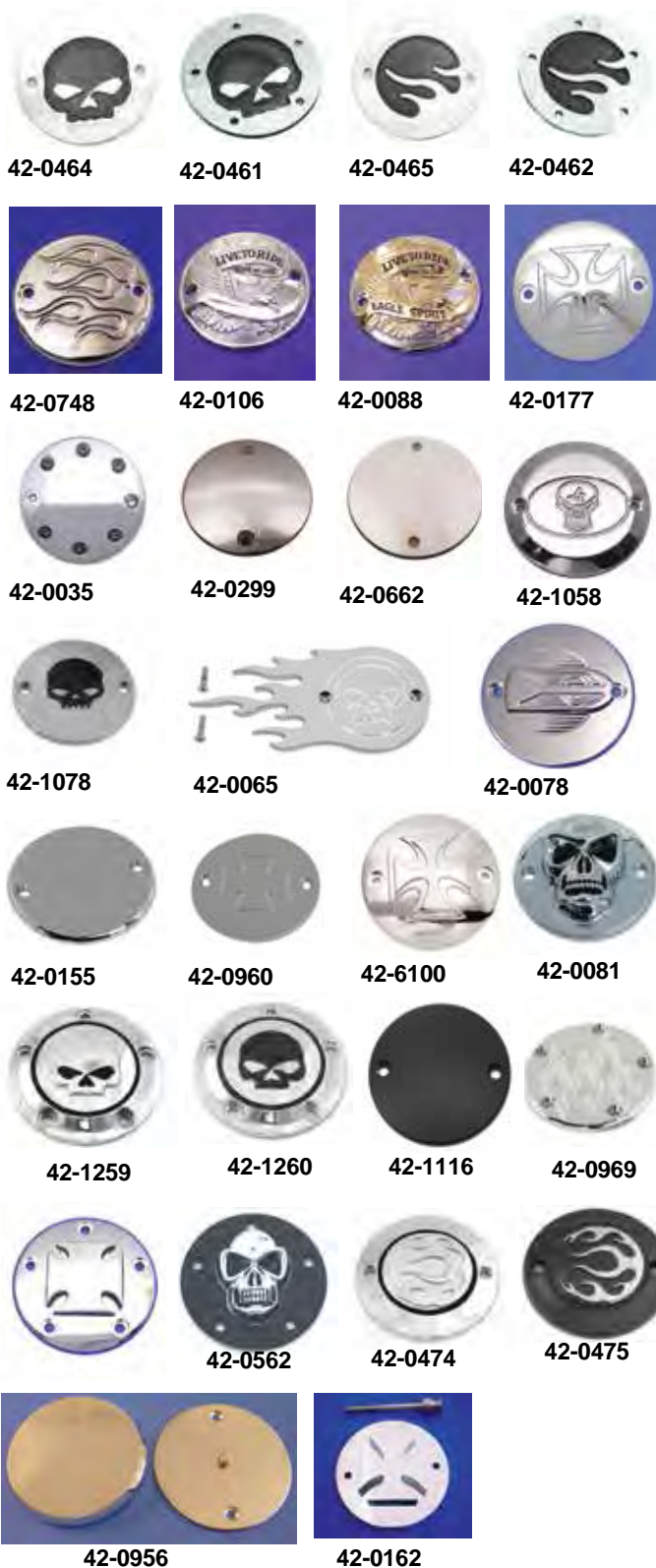



43-0790

Chrome Trans Side & Top Cover Set

• Complete with top cover, side cover, chrome allen screws and chrome allen oil dipstick.

VT No.	Fits
43-0792	FLT 2000-2006
43-0790	FLT 1987-1999



43-0504

43-9136

43-9111

Chrome Transmission Top Cover

VT No.	Fits
43-0504	FLT 2000-2006
43-9136	FLT 1987-1999
43-9111	FLT 1979-1986



Clutch Release Kit

• Inner and outer ramps, 3/8" balls, retaining ring, cable coupling, and cover gasket.

VT No.	Fits
18-3212	FLT 1987-1999



43-0787



43-0789



43-0537



43-9131

Chrome Transmission Cover

VT No.	Fits
43-0787	FLT 2007-up
43-0537	FLT 1999-2006
43-0789	FLT 1987-1999
43-9131	FLT 1987-1999, FLHR 1998

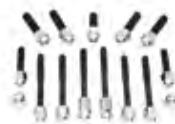

Hardware for Transmission Covers

VT No.	Head Style	Fits
8912-13	Acorn	FLT 1987-2006, FLHR 1998
8912-13-P	As Above	Polished
8908-15	Allen	FLT 1980-1986 5-speed
8404-27	Acorn	FLT 1980-1985

Gaskets for release covers.

15-1051	FLT 1987-2006, FLHR 1998
15-1050	FLT 1980-1986

Chrome Hardware for Release Side Covers

VT No.	Head Style	Fits
9951-12	Acorn	FLT 1998-2006
9952-11	Allen	FLT 1998-2006
8907-5	Allen	FLT 1987-1999

8404-27	1980-85	Acorn
8906-5	1980-86	Allen
8907-5	1988-99	Allen
8907-5T	1988-99	Allen
8910-5	1987	Acorn
8911-5	1987	Cap
8921-5	1988-99	Acorn
8922-5	1988-99	Cap
9952-11-P	2000-06	Chrome



Chrome Transmission Dress Trim

- Fully covers end cover and inner door.

VT No.	Fits
42-0457	FLT 1987-1999



Chrome Engine Dress Up Kit

- Includes chrome covers for oil filter housing, tappet blocks, and oil pump.

VT No.	Fits
42-0654	FLT 1992-1998



42-0794 Installed

Chrome Top Oil Pump Cover

- Use for top replacement cover and includes mounting hardware.

VT No.	Fits
42-0794	FLT 1993-1995, FLHR 1993-1998



Chrome Oil Pump Cover

- Mounts onto the existing bolts on Big Twin models.

VT No.	Fits
42-0530	FLT 1992-1998
42-0011	FLT 1979-1991



Chrome Engine & Trans Interface Cover

- Designed to cover oil lines and cleans up the area in between the motor and transmission and still allows easy removal of dipstick.

VT No.	Fits
42-0698	FLT 1999-2001



Chrome Oil Hose Cover

- Includes all chrome plated mounting hardware

VT No.	Item	Year
42-0695	Oil Hose Cover	1999-06 FLHT
9949-6	Acorn Mounting Kit	
9949-6T	Acorn Mounting Kit	
9950-6	Allen Mounting Kit	
9950-6-P	Polished Allen Mounting Kit	



42-0887

Chrome Oil Filler Spout

fits 1993-06 FLT models. Replaces 62470-06.
VT No. 42-0887



Oil Filler Spout Cover will match the chrome transmission interface cover. Fits 1999-01 FLT.
VT No. 42-0824



40-0673



17-1542



8405-2



8803-2



8804-2

Transmission Filler Plug with Dipstick

- All plugs are chrome except 8804-2 as noted.

VT No.	Head Style	Fits
40-0673	Hex	FLT 2007-up
17-1542	Hex	FLT 1980-1986
8405-2	Acorn	FLT 1980-1986
8803-2	Cap	FLT 1980-1986
8804-2	Gold Cap	FLT 1980-1986



Chrome Billet Forward Control Kit

• Bolt on for FLT models and includes a decorative plug for the shifter shaft hole. Related items also listed.

VT No.	Item	Fits
22-0905	Forward Control Set	Custom application
23-0013	Chrome Master Cylinder	FLT 1999-2007



42-0973



23-0768



23-0968

Rear Master Cylinder Reservoir Cover

VT No.	Fits
23-0968	FLT 2008-up Rear
42-0973	FLT 2005-2007
23-0768	FLT 1999-2004
23-0770	FLT 1999-2004



A 23-9196

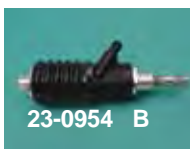

23-0954 B



C 23-0772



D 23-0013



E 23-0874



23-1703

Complete Remote Mount Master Cylinders.

VT NO.	#	OEM	Fits
23-9266	A	41755-86	1986-91 FLT Chrome
23-0954	B	41755-92A	1992-94 FLT Black
23-0772	C	41755-95	1995-96 FLT Black
23-0874	E	41708-08	2008-UP FLT Chrome
23-0011	D	2000-05	Master Cylinder, Body and Top Chrome
23-9264	D	41777-05A	2006-up FLT Chrome
23-0874	E	41708-08	2008-UP FLT Chrome
23-1702	C	41755-95	1995-96 FLT Chrome
23-1703	C	41755-97	1997-98 FLT Chrome



Police Style Shifter Control Kit

• Clamps to the left front lower neck tube saddle on touring models. Fits 1980-up FLT 5 Speed
 • Saddle includes a smooth gate, and fits 1 1/4" diameter tube
VT No. 22-0736

23-9317



23-0969



26-0179



24-0604



23-0782

Front Master Cylinder Covers

VT No.	Style	Fits
23-9317		FLT 2014-up
23-0969	Smooth	FLT 2008-up
26-0179	Smooth	FLT 2005-2007 Front
23-0779	Smooth	FLT 1996-2005
24-0604	Smooth	FLT 1996-2005
23-0781	Billet Milled	FLT 1996-2005
23-0782	Flat	FLT 1995-2005



Chrome Shifter Rod Kit

• With swivel arms is 11" overall length.

VT No.	Includes Arms	Arm Length
21-2122	Yes	11"
21-2039	No	11"
21-0502	Yes	10½"



Custom Shifter Rod.

• Swivel ends and studs built in.

VT No.	Style	Fits
21-0685	Chrome Flame	FLHR 1994-up
21-0991	Black Skull	FLHT 1999-2012
21-0992	Chrome Skull	FLHT 1999-2012
21-0852	Black Flame	FLT, FLHT, FLHR 1980-1998
21-0853	Black Flame	FLT, FLHT, FLHR, FLHX 1990-2010



Custom Shifter Rod.

• Measured relative to stock length. For custom applications.

Style	Length	Stock Length	+2"
Chrome Ball Milled		21-0286	21-0282
Black Ball Milled			21-0349
Black Agostinni		21-0342	21-0343
Chrome Drilled			21-0284
Black Ball Milled		21-0821	
Black Agostinni		21-0822	



Custom Chrome Shifter Rod.

• Measurement includes threads or custom applications

Style	11"	12¼"	13¾"
Skull	21-0581	21-0582	
Flame	21-0555	21-0552	21-0544
Maltese	21-0556		
Skulls	21-0557	21-0554	
Goth	21-0560	21-0559	
Sword	21-0563	21-0562	21-0561
Lady Luck	21-0566		21-0564



Chrome Shifter Maltese Rod Kit.

• With swivel arms is 11" overall length.

Rod measures 10¾" long and has an overall length including rod ends of 13¼".

VT No.	Fits
21-0680	Custom application



Shifter Levers

• Styles as noted. *Note: Two of VT No. 21-0072 are required for complete assembly.

VT No.	Style	Fits
21-0335	Center Balanced	FLT, FLHT 1986-up
21-0072*	Slotted	FLT 1983-up
21-0681	Offset Balanced	FLT 1986-up



Chrome Stock Replacement Shift Levers

• With internal spline.

VT No.	Fits
21-2056	FLT 1983-1996, FLT 2000-up
21-2042	FLT 1982-1999



Chrome Inner Shifter Levers

• Include a stainless steel allen screw and washer.

VT No.	Style	Fits
17-0968	Stock	6-Speed 2006-up FLT
17-0966	Stock	5-Speed 1980-06 FLT
17-0666	Sickle	5- or 6-Speed 1980-06 FLT



Stock



Chrome Extended Shifter Lever

• Measures 9 $\frac{3}{4}$ " long for extended reach. Constructed of steel with chrome finish.

VT No.	Fits
21-0256	FLT 1986-up
21-0871	Set



Chrome Lever

• Features a swivel footpeg mount slot to fold out of the way.

VT No.	Fits
21-0471	FLT, FLHT 1988-up



Shifter Shaft Spacers

• For use with heel/toe shifters. 21-0107 is used to eliminate the heel shifter or for use on single shifter models.

VT No.	Item	Fits
21-0106	Short with Grease Elimination Spacer	FLT 1979-up
21-0108	Short with Anti-Rattle Washer	FLT 1979-up
21-0107	Long with Anti-Rattle Washer	FLT 1979-up



21-0386
Installed



21-0050 Installed



21-0386



21-0050



21-0055

Billet Heel Toe Shifter Set.

- Feature black or chrome finish with billet or without milled slots.

VT No.	Style	Fits
21-0386	Chrome Slotted	FLT, FLHT 1986-up
21-0389	Black Slotted	FLT, FLHT 1986-up
21-0050	Chrome	FLT 1986-up
21-0055	Black	FLT 1986-up



Brake Pedal

23-0472

23-0472
Adjustable

Chrome Adjustable Forward Brake Pedal

- Allows multiple positions.

VT No.	Fits
23-0472	1997-07 FLT

23-0402



Chrome Forward Pedal

- Allow full use of footboard as pedal pad is moved to the edge of the board.
- Includes rubber pad.

VT No.	Fits
23-0402	FLT 1997-07



23-0477



23-0477 Installed with pedal pad

Billet Pedals

Slot Chrome	Black Contrast	Smooth Chrome	Years
23-0937	23-0061	23-0057	FLT 2008-up
23-0062	23-0828	23-0059	FLT 2008-13
23-0830	23-0064	23-0058	FLT 2014-up
23-0477			FLT 1997-07
Extended			
23-0819			FLT 2008-13

Slotted 23-0244



Solid 23-0668



Chrome Extended Brake Pedals

- Constructed of chrome steel with 2 1/4" extension.

VT No.	Style	Fits
23-0668	Solid	FLT 1997-2007
23-0244	Slotted	FLHT 1997-2007

23-0824



28-0761



28-0886



28-2252



28-2233

23-0824
Installed

Billet Brake Pedals

VT No.	Style	Fits
23-0824	Black Skull	FLT 1980-up
28-0761	Chrome Flame	FLT 1980-up
28-2252	Three Inserts	FLT 1980-up
28-2233	Stock Rubber	FLT 1983-up
28-0886	Stream Liner	FLT 1980-up

Note: Pedal pads feature die cast backing with black rubber insert pads.



Chrome Caliper Mount Bolt Kits mount through caliper to bracket.

VT No.	OEM	Type	Year
23-0140	44039-86	6 Point Rear	1987-99 FLT, Chrome
23-0125	44039-86	12 Point	Black, As Above

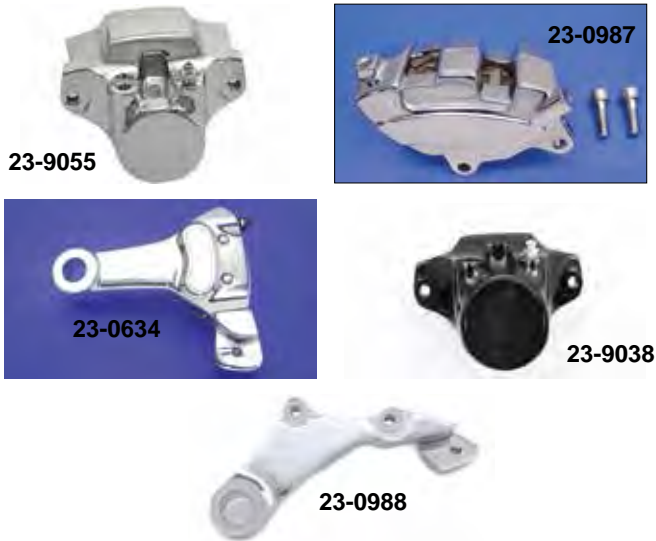

Chrome Rear Calipers

• Completely assembled with piston and seals but less mount brackets for exact stock replacement.

VT No.	Fits	Note
23-9055	1986-99 FLT	
23-0634	2002-07 FLT	Bracket
23-0987	2008-up FLT	
23-9038	1986-99 FLT	Caliper, black
23-0988	2008-up FLT	Bracket



FLT-FLHT Chrome Brake Disc Covers

• Fit FLT with dual disc. Completely covers the front disc. Includes required spacers. Sold in pairs.

VT No.	Years	Type
42-0706	2000-up	Caliper Cover Set



FLT			
20-0599	00-03	1.50	Chrome
20-0375	00-03	1.50	18
20-0359	04-up	1.125	Chrome



Rear



Chrome Caliper Kits

VT No.	Years
23-0815	2008-up
23-1101	2002-07
22-0372	1986-99



Chrome Rear Disc Cover

• Bolts on for a secure installation.
• Fits 1981-83 FLT-FLHT.
VT No. 42-0335

Belts

23-0441



Big Twin, 1.50" Wide				
Carlisle	Goodyear	BDL	OEM	Tooth/Model
20-4010	—	20-0441	40001-85	136T 1984-96 FLT-FLHT
20-4016	20-0726	20-0455	—	135T Big Twin Ratio Change
20-4018	—	20-0579	40024-97	139T 1997-03All FLT
Big Twin, 1.125" Wide				
BDL	OEM	Tooth	Model	
20-0668	40024-04	139T	2004-up FLT	



Front



23-2226



23-0581



23-1712

Front Caliper Sets

VT No.	Fits
23-2226	1984-99
23-0581	2000-07
23-1712	2008-up



44-0219



44-0127



44-0471



44-0715

Chrome Rear Axles

VT No.	OEM	Year	Model	Length
44-0219	41110-79A	1980-99	FLT	12½
44-0127	41110-89	2000-07	FLT	12½
44-0471	41056-02	2002-07	FLT	12¼
44-0787	41056-08	2008	FLT	
44-0715	41056-09	2009-up	FLT	



Dual Disc Caliper Set fits 2008-up FLT Touring models. Right and left.

VT No. 23-1712



Black Rear Caliper.

23-9038 44076-86A 1986-99 FLT

23-1570



23-1571

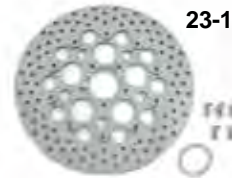

Front Caliper Adapter Brackets allow the use of 13" floating brake disc on models listed by raising stock caliper. Brackets are a clear anodized finish.

VT No.	Item	Fits
23-1567	Bracket, Right	1986-99 FL
23-1568	Bracket, Left	1986-99 FXST, FL, 1991-99 FXDWG
23-1569	Bracket, Right	2000-up FLT
23-1570	Bracket, Left	2000-up FLT, FLST, FXDWG
23-1571	Front Brake Disc	For Above Stainless

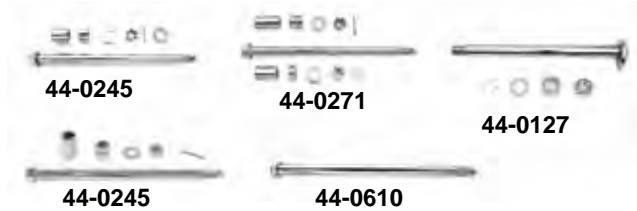

Rear Axle Kits

• Include chrome axle, nuts, sleeves and spacers for each application. Nut kit includes axle nuts in chrome. Fits belt drive.

Kit	Spacer	Axle only	Model/Year
44-0245	—	44-0610	1986-99 FLT
44-0247	2026-5*	—	2000-01 FLT
—	—	44-0127	2000-07 FLT
44-0241	—	—	2002-07 FLT
44-0275	—	—	2008 FLT
44-0271	—	—	2009-up FLT

*Note: Includes Nut Kit



23-0975

FLT Brake Pad Pin Kit

- Includes two pins & two retaining clips for stock type calipers only.
- Fits 2008-up FLHT, FLHR, FLHX and FLTR models.
- Includes pad set.
- Front Kit includes brake pads and pins for right and left caliper.
- Rear kit has one set of pads and pins.

VT No.	Fits
23-0975	Front
23-0976	Rear

23-0976

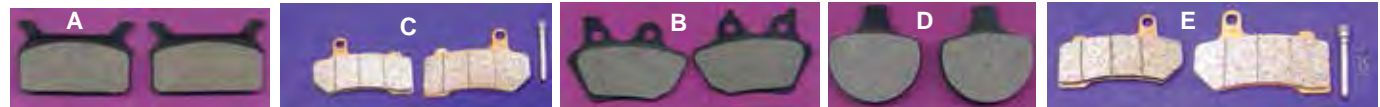

Fits	OEM	Dura Soft	Dura Ceramic	Dura Semi-Metallic	Dura Kevlar	Dura Sintered	SBS Sintered	SBS Ceramic	SBS Carbon Tech	Photo
Rear Disc Pad Sets for Stock Type Calipers										
1986-99 FLT	43957-86A	23-2282	23-0991	—	23-0627	23-0956	23-1778	23-1748	23-1777	A
2000-07 FLT	44082-00	23-0526	23-0993	23-0643	23-0546	23-0958	23-4559	23-1781	23-1782	B
2008-up FLT	41852-08	23-1015	23-0995	23-0894	23-0889	—	—	—	—	C
2009-13 Trike	83911-09B	—	—	—	23-0973	23-0980	—	—	—	—
Front Disc Pad Sets for Stock Type Calipers										
1984-99 FLT,	44063-83	23-0512	23-0996	23-0647	23-0625	23-0960	23-1784	23-1762	23-1785	D
2000-07 FLT	44082-00	23-0526	23-0993	23-0643	23-0546	23-0961	23-4561	23-4560	23-1782	B
2008-up FLT	41854-08	—	23-0998	23-0894	23-0890	—	—	—	—	E



11.5"



Dura Rotor		Russell		OEM	Bolt Kit	Fits
Polished	Standard	Polished	Standard			
FRONT						
23-0343	23-0334	23-9040	23-0319*	44136-84	8793-5 Cast 8794-10 Wire	1984-91 FLT
23-9206	23-0368	23-9040 1984-99	23-0319* 1984-99	44136-92	8793-5 Cast 8794-10 Wire	1992-99-FLT Cast or Wire Wheel
23-0467	—	—	—	44136-92	8793-5 Cast 8794-10 Wire	1992-99 FLT
23-0356	23-0379	23-9048	23-9049	44156-00	8793-5 Cast 8794-10 Wire	2000-up FLT Cast or Wire Wheel Left Side Brake Disc
23-0938	—	—	—			2014-up FLT

*Note: Stainless

23-1040



23-1540

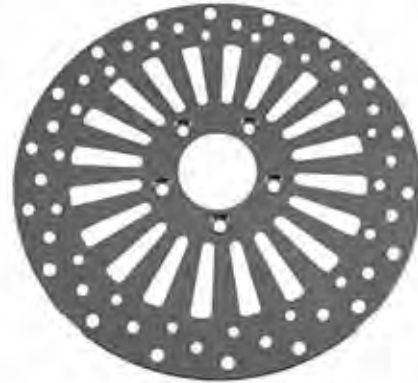

Front Brake Rotor For Touring

23-1040	2008-up	Front (Pair)	Stainless
23-1041	2008-up	Front, Right	Stainless
23-1535	2008-up	Front	Polished Stainless
23-1540	2008-up	Front	Stainless
23-0906	2014-up	Front	Stainless

Wyatt Gatling Polished Spoke Rotor.

20 Spoke	18 Spoke	Type	Year
23-0149	23-0679	Front	1984-99
23-0151*	23-1517*	Front	2000-up
—	23-1529	Front	2008-up

*Note: Will not fit 2008-up FLT models



Brake Rotor.

- Stainless or polished stainless.
- Fits 2008-up FLT.

VT No.	OEM#	Application	Finish
23-6764	41500022	Left	Stainless, Polished
23-6765	41500022	Left	Stainless
23-6768		Right	Stainless, Polished
23-6769		Right	Stainless

23-0694



2000-07 Front Dura Brake Rotor.

- Vented swirl slots.

Polished			
VT No.	OEM	Type/Side	Model
23-0694	44156-00	Front, Left	FLT
23-3774	44136-00	OE Styled	FLT
23-0598	41797-00	Rear	Polished Stainless
Brushed Finish			
23-0535	44156-00	Front Left Custom	FLT



Polished Stainless



23-0357

Standard Stainless



23-0354

Replica Brake Discs

• Feature full stainless construction with precision ground finish and slot style pattern.

Dura Rotor		Russell		OEM	Dia	Bolt Kit	Fits
Polished	Standard	Polished	Standard				
REAR							
23-0260	23-0354	—	—	40939-86A	11.5"	9807-10	1986-99 FLT
23-0357	23-0387	23-9050	23-9051	41797-00	11.5"	9807-10 Wire 9818-5 Cast	2000-up FLT Cast or Wire
23-0598	—	—	—	41797-00	11.5"		2000-09 FLT
23-1043	—	—	—	41791-10	11.5"	9807-10 Wire 9818-5 Cast	2010-up FLT



42-1014



20-0832



20-0751



42-0963

Chrome Outer Pulley Covers

• Fit over pulley and mount with the original five screws.

Chrome	Black	Glossy	Tooth	Fits
42-1014	—	—	66	FLT 2007-up
—	20-0832	20-0751	70	FLT 2007-2013
42-0963	—	—	70	FLT 2004-2006



Wyatt Gatling Polished Spoke Brake Disc.

18 Spoke	Type	Year
23-0678	Rear	1979-99
23-1518	Rear	2000-up
23-0895	Rear	1979-93



23-1530



23-1533

Wyatt Gatling Rear Brake Disc 11.8"

VT No.	Item	
23-1530	18 Spoke Style	2008-up rear
23-1533	X-Spoke Style	2008-up rear



Front Brake Rotor Bolts and Spacer Set

• For one side. Fits 2014-up FLT.

VT No. 23-0943



24-0085



6° Raked Triple Tree Set

• For FLT models features 6° rake over stock tree set. Allows use of larger diameter wheels while still retaining the use of stock cowling assembly.

VT No.	Fits
24-0085	FLT 1997-2013



1987-up FLHT Chrome Lower Fork Stem Cover

VT No.	OEM
42-0911	66058-01



24-2042



24-2043

Billet Lower Leg Cap

• Replaces stock cap.

VT No.	Year	Fits
24-2042	1986-99	3/4" Axle
24-2043	2000-up	1" Axle



Chrome Lock Cover

• Fits 1994-2002 Road King.
• Cover pivots to allow access to fork lock.

VT No. 48-0424



41 mm Fork Leg Rebuild Kit

• For 2014-up FLT.

VT No. 24-1056



Chrome Fork Dress Up Kit

• Includes lower legs, upper fork cover, axle spacer set and outer nut covers. All necessary hardware is included for installation.

VT No.	Fits
24-1245	FLHR 2000-13, FLT 2000-13, FLHT 2000-13



42-0920

Lower Triple Tree Cover

• Completely covers underside of tree.

VT No.	Fits
42-0920	FLT 2001-13



24-0212

24-1314



Replica Chrome Forged Steel Triple Tree Set

• Includes lower bearing pressed on, dust shield set and upper bearing and cone nut.

VT No.	Fits
24-0212	1984-08 FLT
24-1314	2009-13 FLT



41 mm Fork Tube and Slider Assembly

• Available in right and left pairs, completely assembled.
• Units have hard chrome fork tubes, and either polished or chrome lower sliders, with springs and all internal components installed.

VT No.	Disc	Fits	Slider
24-0522	Dual	1984-99 FLT	Chrome
24-0538	Dual	2000-13 FLT	Chrome



24-1221



24-2223

Chrome Fork Assembly

• Features chrome triple trees, chrome or polished lower legs, axle, chrome upper fork covers and full chrome cowl and handlebar top chrome cover assembly. Units accept dual disc caliper as required by year. 1984-86 models require 1987-99 front caliper set.

1984-99

24-1220	Polish
24-1221	Chrome
2000-06	
24-2223	Chrome

Triple Trees for 2009-13

VT No.	Item	Finish
24-1311	Top	Chrome
24-1312	Lower	Chrome
24-0313	Lower	Black



24-0212



25-0985

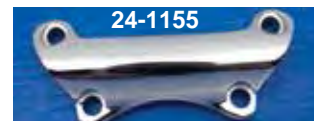

24-1155

Chrome Tree Set

VT No.	Item	Year
24-0212	Tree Set	1984-08
24-1314	Tree Set	2009-13
25-0985	Riser Set	1988-up
24-1155	Riser Top	2008-up

2736-1



2737-1



FLT Top Fork Tube Plugs.

VT No.	Year	Type
2736-1	1984-01	Top
2737-1	1984-01	Lower



24-9999



24-0211



24-0178



24-0268



24-0210



17-0949

FLT Fork Assembly

Fits 1984-99 FLT and includes chrome lower sliders with all internals and stock length tubes installed, chrome triple tree set, chrome slider covers, axle, bearings and dust covers. Accepts FLHR cowl set not included. Also accepts 11.5" dual disc components.

VT No.	Item
24-9999	Fork Assembly Complete w/Chrome Sliders
52-0856	16" Chrome Wheel
24-0355	Cowl Assembly
24-0268	Top Handlebar Chrome Cover
31-0246	Cowl Top Trim Piece
24-0522	Right and Left Leg Assembly, Chrome
24-0210	Chrome Upper Tree
24-0211	Chrome Lower Tree
24-0178	Black Upper Fork Triple Tree
24-0212	Chrome Tree Set
24-9960	Chrome Slider Covers
37-0860	Slider Cover Screws
24-0772	Fork Installation Kit
44-0675	Axle Kit Only
17-0949	Nut Lock Tab
37-1010	Pinch Bolt Set



Fork Stem Nut Wrench

• Fits FLT.

VT No. 16-1977



Neck Hardware Kit

• FLT 1980-up
• Available separately.
VT No. 24-0367



24-0694

24-0389

24-0394

24-0397

Lower Fork Slider Set.

- Include seals and lower leg cap.

Chrome	Black	Fits	MM
24-1369		FLT 1986-99	41
24-0694		FLHT 2000-2013, FLHR 2000-2013	41
24-0389	24-0398	FLT 2000-2013; does NOT include the lower leg cap	41
24-0396	24-0398	FLT 2000-13	41
	24-1368*	FLT 2014-up Note: Assembly	41
24-0394	24-0397	FLT 2014-up	41
24-0395		FLT 2000-2013	41
24-0593		Polished, FLT 1986-1999	49

24-1563



20th Century Fork Spring Lowering Kit.

- Progressively wound springs that resist bottoming out.
- Installation requires minor disassembly to lower the front forks 1 1/4" or 2" depending on the spacer used. Kit includes springs, spacers and hardware. Easily converts back to stock by re-installing stock fork springs.

VT No.	Size	Year/Model
24-1563	41 mm	1997-up FLT
24-2100	41 mm	2000-up FLT



Monotube Fork Cartridge Kit.

- By Progressive Suspension converts dual damper rod forks to high performance cartridge forks. Improves resistance to front brake drive, front end stability and cornering control.

VT No.	Fits
24-2101	1984-96 FLT, FLHT, FLHT, FLHR, FLHX
24-2100	1997-up FLT, FLHT, FLHR, FLHX



Fork Tube.

FLT-FLHT

1984-96 FLT, FLHT, FLHR 41mm.

24-0411	Stock 20 7/8"
24-0027	As above Hard Chrome
1997-13 FLT, FLHT, FLHR, 41mm	
24-0045	Stock 20 7/8"
24-1352	2" over stock Hard Chrome



24-1453

Fork Lowering Kit.

- Fits 2014-up FLT with 49 mm fork tubes.

VT No. 24-1453



Black Handlebar Riser Cover.

- Fits 2014-up FLT with 49 mm fork tubes.

VT No. 24-1046



Fork Steering Damper Kit.

- Attaches to lower fork stem and crash bar

VT No.	Fits
24-1371	FLT 2000-2013
24-1372	FLT 2014-up



24-1166



24-1173



24-1167



24-1183



24-1159



24-1169



24-1168



24-1165



24-1172



24-0386



24-1171



24-1170



Fork Slider Cover Sets

- Black and chrome slider cover sets in various styles as noted.
- For FLT 1980-2013

Chrome	Black	Style
24-1166	24-1173	Grooved
24-1167		Tribal
24-1183	24-1159	Agostinni
24-1169	24-1168	Smoke Stack
24-1165	24-1172	Bellowed
24-0386		Flame
24-1171	24-1170	Tapered w/ Contrast Rings



24-9960



24-9986

Fork Slider Cover

- Fit 1980-2013 FLT model forks.
- Stock length is 6 5/8" overall.

VT No.	Finish	Style
24-9960	Chrome	Smooth
24-9986	Stainless	Smooth



24-1047



24-1048



24-1182



24-1180

Fork Slider Cover Set

- Fits 2014-up FLT

Chrome	Black	Style
24-1047	24-1048	Fork Slider Cover Set
24-1182	24-1180	Edge Cut w/ milled accents
24-1192	24-1193	Billet Smooth
24-0387	24-1558	Flame



24-0190



24-1365



24-1752



24-9962



24-1047

Stock Slider Covers

- Stock length is 6 5/8" overall.

VT No.	Fits	Finish
24-0190	FLH 1949-1984	Chrome
24-1365	FLT 1980-2013	Chrome
24-1752	FLT 1980-2013, FLH 1949-1984	Black
24-9962	FLH 1949-1984	Stainless
24-1047	FLT 2014-up	Chrome
24-1048	FLT 2014-up	Black



AEE Series Shock Sets

- Nitrogen charged with multi stage dampening and adjustable spring load. All shocks are measured eyelet to eyelet and feature chrome springs and caps with black body. ***Note:** Denotes stock length.

Fits	11"	11.5"	12.5"	13"	13.5"	14.25"
1980-04 FLT	54-0020	54-0021	54-0022	54-0023*	54-0024	54-0025
1980-04 FLTS	54-0133	—	—	—	—	—



Chrome Low Touring Shocks

- Lower the seat height without altering the ride.
- Low Touring Shocks have been revalved for a comfortable ride while lowering the seat height by up to 3/4". The air adjustability feature of the stock shocks will be retained.

VT No.	Model	Brand
54-0147	2002-up FLT, FLHT, FLHS, FLTR & FLHR	AEE
54-0148	1991-01 FLT, FLHT, FLHS, FLTR & FLHR	AEE
28-0535	Rear Rubber Boot Set 1997-2012 FLT	



Progressive Suspension 412 Series Chrome Shocks

- Manufactured from the finest material available.
- Magnum 412 Series shocks are nitrogen charged with six-stage automatic damping and an adjustable spring preload.
- Available with chrome spring and end caps, shock cartridge is not chrome.
- All shocks are measured eyelet to center of eyelet.
- Fit 80-04 FLT, FLHT, FLHS

11"	11.5"	12.5"	13.0"	13.5"	14.5"
54-0093	54-0033	54-2000	54-2001*	54-2002	54-0059



Progressive Suspension 440 Series Chrome Shocks

- Feature two rebound damping circuits and are available in standard for the average single rider, heavy duty for touring or carrying passengers.
- Fits 1980-04 FLT

Standard	Heavy	Size
54-4006	54-4011	11.5"
54-4049	54-4050	12"
54-4001	54-4019	12.5"
54-4003	54-4021	13.5"



Digital Shock Pump

- Includes pressure gauge replaces 54630-03A from 0-60 PSI.
- VT No. 16-0002



16-0041

Shock Pump

- Includes pressure gauge replaces 54630-03A from 0-60 PSI.
- VT No. 16-0041



16-0578

Shock Pump

- Pressure gauge 0-60 PSI.
- VT No. 16-0578



16-1110



16-1600 Installed



16-1109



16-1600

Center Stand

- Bolts directly to the FLT model frame.
- Lifts the bike upright and stands by activating the lever on the left side. In this position the bike looks great for display or servicing.

* **Note:** Adjustable Height

VT No.	Type	Fits
16-1110*	Chrome Adjustable	FLT 2009-up
16-1116	Black Adjustable	FLT 2009-up
16-1109	Chrome Adjustable	FLT 1989-2008
16-1600	Black Non-Adjustable	FLT 1980-2008

27-0070



27-0853

Kickstand Angle Plate

- Fits FLT 1981-up.

VT No.	Item	Finish	Use
27-0070	Plate	Alloy	Extended Forks
27-0853	Kit	Chrome	Lowered Forks



Black Rear Shock Lowering Kits

- Lowers rear frame area.
- Includes instructions, hardware and black brackets.

VT No.	Fits	Lowers Frame Area
54-0508	1985-1996 FLT	1 1/2"
54-0521	1997-2001 FLT	1 1/2" (except FLHRCI)
54-0534	2002-2003 FLT	1 1/2"
54-0125	2004-2010 FLT	1"
54-0126	2004-2010 FLT	1 1/2"



51-1607



51-1609



51-1601
Installed



51-1601

51-1602



The Touring Torque Linkage System

• No modifications are necessary to install this unit. After the unit is installed it will eliminate the lateral movement while still allowing the Iso mounted factory design of the "floating" drive train to move vertically as designed through connecting the rear of the transmission case to the frame. The kit utilizes an isolation link with a urethane plunger so there is no contact between the frame and engine transmission assembly, therefore reducing vibration.

• Fits 1993-08. 51-1602 includes outer mount bracket in chrome.

VT No.	Finish	Fits
51-1607	Chrome	FLT 1993-2008
51-1609	Black	FLT 1991-2008
51-1601	Black	FLT 1993-2008
51-1602	Chrome	FLT 1993-2008

Note: Installation on 1993-2001 models require 27-1235 foot peg spacer set as shown. Purchase 27-1235 separately.



Touring Wide Swingarm Kit

- This new wide swingarm kit come complete with all bolt-on parts necessary to install without modification.
- Kits include new wide rear swingarm with a 1" axle, custom 14 gauge rear OE style fender, saddle bag support kit, drive components, billet primary spacers and all brackets and hardware necessary.
- Allows use of OE stock tail lamp, saddle bags and exhaust.
- Accepts 16" x 5.5" x 17" x 5.5" x 18" x 5.5" rear wheels and most tires up to 200mm wide.
- Requires a 20mm rear belt and pulley.
- Models with 18" rear tire, use OE brake caliper, models with 16" rear tire require a smaller custom brake caliper.
- Installation of a tour pak or backrest will require OEM detachable docking hardware.
- Fits 2002-06 FLHT, FLHR and FLTR touring models.

VT No. 51-1252



1998-08 Frame for FLHR

• Accepts stock components for these years. Frame shipped in raw finish without swingarm.

VT No. 51-0800



Tri Glide Leveling Kit

• Includes 2 black painted steel plates to raise the rear axle position for installing custom muffler.

VT No. 51-1744



Twirled Spoke Wheels

• Include chrome hubs with internals, rim and twirled chrome spokes assembled.

VT No.	Fits	Type	Width
FRONT			
52-0859	1984-99 FLT	16"	3.00"
REAR			
52-0858	1986-99 FLT	16"	3.00"
52-0976	2000-01 FLT	16"	4.00



52-1243

Profile Rear Wheels for Touring

• Include the new development of a 3.0" x 16" smoothie rim. Wheels include chrome spokes, chrome hub and profile rim.

VT No.	Year
52-1243	2002-07
52-1240	2000-01
52-1242	1986-99



Flush Mount Front Axle Kits

• A new way to dress up your front wheel without the hex nut and lug sticking out.

• Kit includes two chrome washers and two chrome flat head

VT No.	Fits
44-0936	FLT 2008-up
44-0935	FLT 2000-2007
44-0001	FLT 2000-2007
44-0002	FLT 1984-1999

Fits	Kit	Nut	Axle	Fork	Dia
1984-99 FLT	44-0675	9989-4	44-0208	41 mm	.750"
2000-07 FLT	44-0673	2036-5	44-0359	41 mm	1"



Rear Axle Kit includes spacers, nut and axle in chrome. Fits 2009-up FLT.
VT No. 44-0271

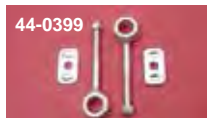

FLT Axle Adjusters

44-0399	1984-96
44-0601	1997-01



Chrome Rear Wheel Spacer Set fits Touring models.

VT No.	Year
44-1977	2002-07



Wheel Spacer Kits

• For Touring, front axle with 1" inner diameter.

VT No.	Type	Year
2036-5	Smooth	2000-07
2035-5	Grooved	2000-07
2507-5	Smooth	2008-up



Chrome Front Axle Spacer Kits

• Include left and right side spacers, washers, and nuts.

Smooth	Grooved	Fits
2507-5	-	FLHR, FLT 2008-up
44-0115	-	FLT 2000-up Front Fitment
2036-5	2035-5	FLT 2000-2007
9989-4	9988-4	FLHR, FLHRCT 1994-up

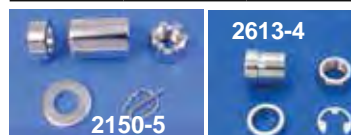

Chrome Rear Axle Spacer Kits.

• Include left side spacer, two axle adjuster collars and castle nut. Kits for Dynaglide include castle nut for axle and adjuster collars.

VT No.	Years
2150-5	2000-01
2613-4	2002-07

Front Axle Spacers

Chrome	Zinc	Side	Fits
	44-0364	Left	1987-94 FLT
44-0370	44-0371	Left	1995-99 FLT

44-0794



Front Axle Kits.

• Axle end and spacers are chrome.

VT No.	Years	Size
44-0676	2000-01	.750"
44-0673	2002-07	1.0", Spacer
44-0794	2008-up	25 mm
44-0750	2000-up	25 mm



52-2008



52-1020

52-0439

Front Spoke Wheel.

• For use on dual disc models without ABS brakes. *VT No. 52-1020 has a smoothie rim.

VT No.	Diameter	Width	Fits
52-1241	16"	3.00"	FLT 2009-up
52-0492	21"	3.25"	FLT 2009-up
52-2008	16"	3.00"	FLT 2005-up
52-0440	21"	3.25"	FLT 2005-2007
52-1095	16"	3.00"	FLT 2000-2004
52-0439	21"	3.25"	FLT 2000-2004
52-0856	16"	3.00"	FLT 1984-1999
52-0441	21"	3.25"	FLT 1984-1999
52-1020*	16"	3.00"	FLT 1984-1999



52-1289



52-2037



52-0857

Rear Spoke Wheel

VT No.	Diameter	Width	Fits
52-1245	16"	5.00"	FLT 2009-up
52-1289	16"	5.00"	FLT 2009-up
52-2037	16"	3.00"	FLT 2008-up
52-1099	16"	3.00"	FLT 2002-2007
52-0777	18"	4.25"	FLT 2000-2001
52-0857	16"	3.00"	FLT 1986-1999



Front Wheel Dual Disc

• Fits FLT 1984-99

VT No.	Size/Finish
52-0621	26" x 3.5" chrome, chrome spokes
52-0622	26" x 3.5" chrome, stainless spokes
52-0623	26" x 3.5" chrome, chrome fat spokes



16 Front Spoke Wheel

VT No.	Size
52-0854	Front, Chrome, 1984-99 FLT
52-1096	Front Stainless Steel, 2000-04 FLT



16 Wheel

VT No.	OEM	Size
52-2009	40960-05	16" x 3" Rear, Chrome, 2005-up FLT, front
52-0855		16" x 3" Rear Assembly, 1986-99 FLT, rear



60 Spoke Billet Hub Wheel

• Features chrome plated billet hub, polished stainless spokes and chrome rim.

Front Wheels

52-0739	FLT 2000-up	18" x 3.5"
---------	-------------	------------



50 Fat Spoke Radial Laced Wheel

• Feature 3/8" polished stainless steel spokes, billet chromed hub and polished chrome steel rim. All wheels include bearings, seals and center spacer.

Rear

52-0112	16" x 3.5"	2000-01 FLHT, FLHR, FLTR
52-0113	16" x 3.5"	1984-99 FLHT, FLHR, FLTR
Front Dual Disc		
52-0109	16" x 3.5"	2000-04 FLT, FLHT, FLR
52-0110	16" x 3.5"	1986-99 FLT, FLHT, FLHR



52-0665 16"

Chrome Profile Laced Wheel

- An aluminum rim with a smooth chrome finish.

16" Rear	
52-0665	2002-07 Touring
52-0664	2003-06 FL Softail models and FLT Sidecar
44-0961	Wheel bearing spacer fits FLT 2009-up Rear,



52-1020

Chrome Front Wheel for Touring

- Feature 3.0" x 16" smoothie rim, chrome spokes, chrome hub with internals, laced and trued.

VT No.	Year
52-1020	1984-99
50-0878	2009-up



52-0589

Chrome Profile Laced Wheel

- Aluminum rim with a smooth chrome finish

VT No.	Fits
52-0589	1986-99
52-0665	2002-07



52-0439



52-0440

21" x 3.25" Chrome Front Wheel

VT No.	Year	Model
52-0484	1984-99	FLT Dual Disc
52-0021	1984-99	Dual Disc, 2.15"
52-0021	1984-99	FLT Dual Disc, 2.15"
52-0439	2000-04	FLT Dual Disc
52-0440	2005-07	FLT Dual Disc
52-0491	2008	FLT Dual Disc
52-0492	2009-up	FLT Dual Disc



26" 60 Spoke Wheel

- Bearings included.

VT No. 52-0794



52-0450 23"

23" x 3.00" Chrome Front Wheel

VT No.	Year	Model
52-0461	1984-99	FLT
52-1033	1984-99	FLT
52-0462	2000-04	FLT
52-0463	2005-07	FLT
52-0465	2009-up	FLT
52-0466	2009-up	FLT
52-1026	1973-84	FL



Chrome Rear Fender Tip Lamps

Bulb	LED	Color	Fits
-	50-1160	Red	FLT 2009-up
-	50-1540	Red	FLT 2009-up
-	50-1539	Smoked	FLT 2009-up
-	50-1179	Amber	FLT 2009-2010
-	50-1180	Smoked	FLT 2009-2010
-	50-1181	Clear	FLT 2009-2010
50-1174	50-1175	Amber	FLT 2004-2010
50-1176	50-1177	Smoked	FLT 2004-2010
50-1161	50-1170	Red	FLT 1999-2008
50-1166	50-1167	Amber	FLT 1999-2008
50-1168	50-1169	Smoked	FLT 1999-2008



Front Fender Lamp Set Amber

• For the right and left side of FL type 2 rail stock front bumpers.

VT No.
33-2139



42-0720

Chrome Fender Grill Tip.

VT No.	Fits
42-0720	FLT 1980-up

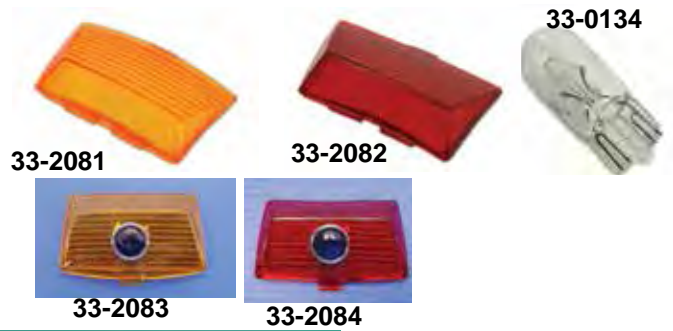

Chrome Plated Tips fit 1979-99 FLT with light.

Front	Rear	Style
50-1025	50-1026	With Bulb Lamp (A)
50-1164	50-1165	With LED Lamp (B)
33-2081	33-2082	Lens only
33-2083	33-2084	Lens only with Blue Dot
15-0695	15-0694	Gasket
33-0134		Bulb, 10 pack



Chrome Front Fender Tip Lamps

• With bulb or LED type lamps, and lenses in various colors.

VT No.	Bulb Type	Lens Color	Fits
50-1162	Bulb	Amber	FLT 2000-up
50-1025	Bulb	Amber	FLT 1985-up
33-0657	LED	Amber	FLT 1980-up
50-1173	LED	Smoked	FLT 2000-2010
50-1171	LED	Amber	FLT 2000-2010
50-1172	Bulb	Smoked	FLT 2000-2010
50-0045	LED	Clear	FLT 2014-up
50-0046	LED	Smoke	FLT 2014-up



50-0691



50-0697

Chrome National Tips.

VT No.	Fits	Model
50-0691	Front front and front back	2000-13 FLT
50-0697	Rear	2002-08 FLT



Chrome Front Fender Lower Trim

- Available in ribbed, flame or smooth
- Screw kit included.

VT No.	Style	Fits
50-1066	Ribbed	FLT 1986-up
50-1132	Flame	FLT 1980-2013
50-1133	Smooth	FLT 1980-up
37-1508	Screw Kit	



V-Design Fender Rail Trim

VT No.	Application	Fits
50-1094	Front	FLT 1980-up
50-1145	Rear	FLT 2009-up
50-1146	Rear	FLT 1984-2008
50-1051	Front	FLST 1986-up



Chrome Fender Trim Strip Set

- For left and right side. Extra t-bolt set also listed.

VT No.	Item	Fits
50-0531	Strip Set	FLH 1957-1984, FLT 1982-2013
37-8784	Tee Bolt Set	FLT 1982-up

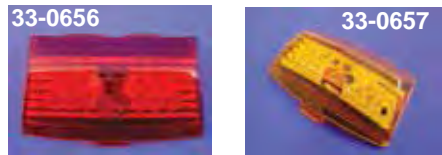

LED Fender Tip Lamps

- Fit 1980-up FLT models.

VT No.	Type	Color
33-0656	Rear	Red
33-0657	Front	Amber



Chrome Front Fender Rail Trim Kit

- Includes six stations, two curved rails, and hardware.

VT No.	Fits
50-1084	Custom application



Chrome Front Fender Bumper Rail

- Available with or without rubber insert

VT No.	Item	Fits
50-1061	Rail w/ Insert	FLT 1983-up
50-0453	Rail w/o Insert	FLT 1983-up
50-1058	Insert	FLT 1980-1999
31-1346	Bracket	FLT 1980-1999



Mud Flaps

- Stock type for front and rear fenders on Big Twin

VT No.	Style
28-0701	Black Rubber
28-0702	White Rubber



Chrome Die Cast Fender Tips

- With skull design.

VT No.	Fits
50-1655	Front
50-1656	Rear



Rear Fender

TOURING



50-0715



50-0717



50-0896



50-0718



50-1517

FLT Replacement Rear Fenders

VT No.	Fits
50-0715	1999-00
50-0717	1991-08
50-0896	2009-up
50-0718	2009-up, drilled
50-1517	2009-up longer
50-1515	2009-up



50-1157
Installed



50-0942



50-0471



50-0860



50-0718



50-1190

Dresser Style Rear Fender

• Undrilled, fits models with modification.

VT No.	Width
50-0942	6.5"
50-0471	7.5"
50-0860	8.0"
50-1525	9.0"
50-1190	9.0"



50-1537



50-1536



48-0135



48-0136



50-1157



48-0246



48-1538



48-1546

Fender Ornaments

VT No.	Style
50-1537	Flying Skull Ornament
50-1536	Skull Ornament
48-0135	Grim Reaper Ornament
48-0136	Bat Ornament
50-1157	Trim Spear with Skull
48-0246	Skeleton Hand
48-1538	Devil Wheel
48-1546	Skull



50-1037

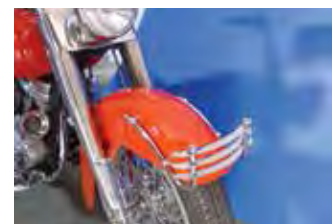

Front Bumper

• Original cutter design. Includes parts pictured for mounting to FLH-FLT front fenders. Fender requires drilling for installation.

VT No.	Item
50-1037	Complete Kit
37-9024	Chrome Eye Bolt Set



50-0946



50-0138



50-0945



50-0039

50-0472

Glide Fork Front Fender.

VT No.	OEM	Year	Type
50-0138	59093-87	1987-99	Replica
50-0945	59093-00	2000-up	Replica
50-0946	Without holes	2000-up	Plain
50-0039	FLHXSE	2010-up	Raw
50-0548	FLH	1987-up	Raw
50-0472	FLH	2014-up	Raw
50-1193	FLH-FLHX	2014-up	Raw



50-1545

50-1548



50-1546

50-1549



50-1548 Installed



50-1549 Installed

Front Fender Lower Trim

• Fits 2014-up FLH

Chrome	Black	Type
50-1545	50-1548	Smooth
50-1546	50-1549	Flame

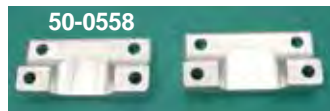

50-0558



31-0761



31-0096

Fender Adapter Brackets

• Allow installation of narrower Fat Kid (FLST Style) front fenders on FLT-FLHT with 16" front wheels.

VT No.	Years	Finish
50-0558	1980-99	Alloy
31-0096	1980-99	Chrome Billet
31-0761	2000-up	Chrome



Fat Kid Steel Front Fenders

• Fit 16" wheels on Glide Forks.

VT No.	Fits
50-0185	1980-up

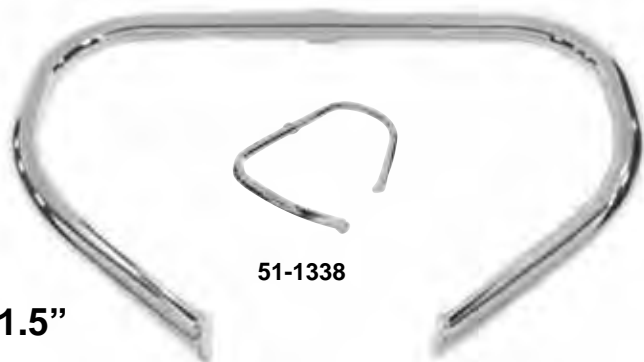

1.5"

51-1338

Chrome Front Engine Bar

- Bar complements the traditional Touring style
- Features 1½" diameter tubing.

VT No.	Fits
51-1338	FLT 1997-2008



51-0991

51-0986

Engine Guard

- Features integrated rubber pads for foot rests.

Chrome	Black	Year	Model
51-0991	51-0871	1997-08	FLT
51-0986	51-0873	2009-up	FLT
28-0852		Rubber Pads	



Rear Engine Bar

- Available in black or chrome.
 - Includes right and left guards and hardware.
- *Note: includes saddlebag supports, right, left guards and hardware.
- **Note: Top of bars are angled downward to provide more leg room for passenger. Use stock supports.

Chrome	Black	OEM	Fits
51-1059	51-1060*	90200791	FLH 2014-up
51-1061*	51-1062*	90200788	FLH 2014-up
51-1057	51-1058	49282-09B	FLT 2009-2013
51-1063**		49179-09	FLHTR, FLHX, FLHXSE, FLTRXSE, FLTRSES, FLHRC 2009-2013

Fatty Freeway Style Front Engine bar features chrome finish.
 Fits:
 FLH 1997-2008. VT No. 51-1247



51-0850



51-0937

Chrome Rear Engine Bar Sets

- Feature left and right side with style and tube diameter as noted.
- Bars do not include reflectors

VT No.	Type	Fits
51-0935	7/8" Regular	FLHT, FLHR, FLHRC 1997-2008
51-0850	7/8" Regular	FLHR 1997-2008, FLHT 1997-up
51-0937	1¼" Buffalo	FLT 1997-2013



50-2065



50-2066

Engine Bars

Big Twin Rear		
50-2065	1996-up	FXST, FLST
50-2066	1994-up	FLHT, FLTR, FLHR
14-0977	O-Ring for Above Front or Rear Bars	

FOR ENGINE BARS:

Warning: These Engine/frame bars may provide limited leg and cosmetic vehicle protection under unique circumstances (fall over while stopped, very low speed slide). They are not made nor intended to provide protection from bodily injury in a collision with an automobile or any other object.



51-1577



51-0878



51-0880



51-0883



51-1338

1 1/4" Chrome Front Engine Bar

- Bar complements the traditional Touring style and features 1 1/4" tubing.

VT No.	Fits
51-1577	FLT 2009-up
51-0878	FLT 1997-2008
51-0880	FLT 1988-1996
51-0883	FLT, FLHT, FLHS 1984-1987 with air
51-1338	FLT 1.5" O.D.

51-2085



Nerf Bars

- Feature built in foot rest.
- 1 1/4" tubing.

VT No.	Fits
51-2085	1997-up FLT, FLT, FLHT, FLHR, 2009-up FL



50-2056

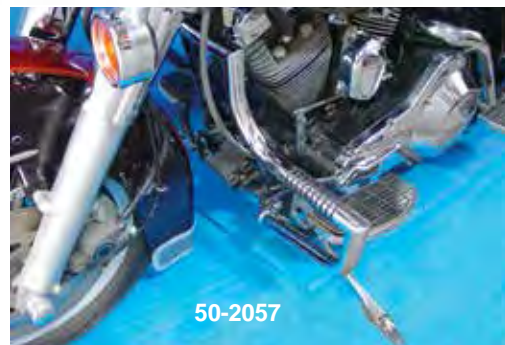

50-2057

Engine Bars

Big Twin Front		
50-2056	1997-up	FLT, FLHT, FLHR
50-2057	1981-96	FLT, FLHT, FLHR



50-2069



Chrome Custom Twinbar Combination Engine Guard

- With built in flip down footpegs. Constructed from 1 1/4" outside diameter tubing.

VT No.	Year	Model
50-2069	1997-up	FLT



30-4052



30-4045



30-0639



30-4044



30-1413



30-3183



30-0598



30-0638



30-0636



30-4095



30-0613



30-0629



30-4053



30-4050



30-4044



30-0598

4" Diameter Chrome Muffler Set

- Measure 4" outside diameter with removable tips.
- Fit 1995-up.

Tip Style	Chrome Tips	Black Tips
Short Tapered	30-4052	-
Medium Tapered	30-4045	30-4053
Long Tapered	30-0639	30-4044
Long Type Tapered	30-1413	-
Hollow Point	30-3195	30-3183
Slash	30-0598	-
Six Screw	30-0638	30-0636
Gun Barrel	-	30-4095
Revolver	-	30-0613
Billet	30-0629	-
Resonator	-	30-4050



30-3110



30-3387



30-0634



30-3392



30-0600



30-4094



30-0635



30-0753



30-0754



30-3383



30-3382



30-0752



30-4055



30-0628

3.5" Diameter Chrome Muffler Sets

Type	Chrome Tips	Black Tips
Long Tapered	30-3110	30-3387
Hollow Point	30-0634	30-3392
Slash	30-0600	30-4094
Six Screw	30-0635	30-0753
Shooter	30-0754	30-3383
Highlighted Shooter	-	30-3382
Long Gun Barrel	-	30-0752
Revolver	-	30-4056
Highlighted Revolver	-	30-4055
Shark Tail	30-0628	



30-0596

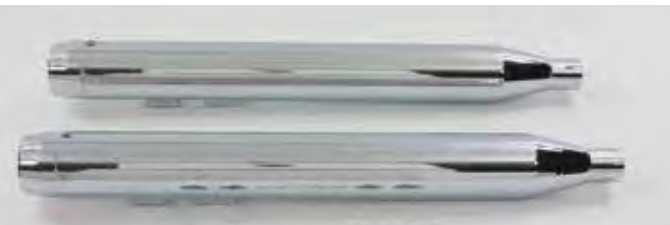

30-0599



30-0601



30-0627



30-0605



30-0845



30-3023

Custom Muffler Tip Set

• Chrome or black finished end caps fit stock mufflers, measured by muffler outside diameter.

For 3½" Diameter

30-0601	Chrome Slash
30-0627	Chrome Shark

For 4" Diameter

30-0605	Chrome Slash
30-0845	Black and Silver Revolver

3.5"

Muffler Sets with Short Tapered End Caps

- Touring style muffler set has a 3.5" outer diameter.
- Available with either a chrome or black body
- Features removable baffles, welded top mounts, accurate inner diameter inlets and formed inlet tubes, with black anodized or chrome end caps.

Chrome Body	Black Body	End Cap
30-0596		Black
30-0599	30-3023	Chrome

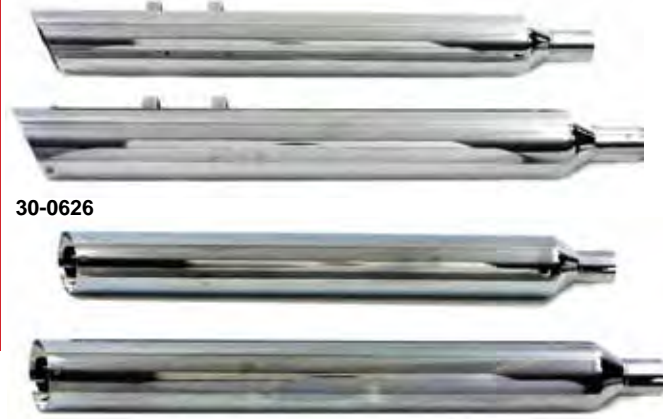

30-0626

30-0597 Slash Down Chrome Muffler Set
 • To stock OE brackets and features removable baffles which can be modified for alternate tuning characteristics.

VT No.	Fits
30-0626	FLT 2009-up
30-0597	FLT 1995-up



30-1568 Vance & Hines Slash Slip-on Muffler Set
 • Round 4" diameter muffer body with a straight through louvered baffle. Chrome finish.

VT No.	Fits
30-1568	FLT 1995-up



Wyatt Gatling Chrome Muffer Set.

VT No.	Item
29-0050	Tapered Tips
29-0051	Vortex Tips



30-0422 Radii Wide Oval Chrome Muffer Sets
 • With built in baffles. Oval shape measures 2½" X 5". This muffer set has an overall length of 27¼".

VT No.	Fits
30-0422	FLT 1995-up



30-1588 Twin Slash Oval Slip-On Mufflers
 • Complete your touring model exhaust system with Vance and Hines oval muffer set. The 4" diameter mufflers add a substantial power increase and crisper throttle response.

VT No.	Fits
30-1588	FLT 1995-up



30-1570 Twin Slash Monster Oval Slip-On Mufflers
 • Vance & Hines FLT twin slash cut mufflers feature full coverage heat shields for blue proof protection.

VT No.	Fits
30-1570	FLT 1995-up
30-1581	FLT, FLHT, FLHR 2009-2010



30-0010



30-0011



30-0012



30-0013

4"

4" Wyatt Gatling

Chrome Tip	Black Tip	Type
30-0010	30-0011	High Output
30-0012	30-0013	Ball Milled
30-1305		Vortex
30-1303		Taper
30-0932		Megaphone
30-4005		Medium with tapered ends

30-3384



30-0213

Wyatt Gatling Chrome 31"

- Turnout Muffler Set



VT No.	Fits
30-3384	FLT 1995-up
30-0213	FLT 1985-1994



30-1305



30-1303

Wyatt Gatling Reverse Cone Vortex Type

30-1305	Chrome with black tip
30-1303	Black with chrome tip



Wyatt Gatling Tapered End Caps

30-1603	Chrome with black end cap
30-1605	Black with chrome end cap



30-1605

3"



30-3184

Short Tapered Tip Chrome Muffler Set

- 3" diameter.
- Features chrome short tapered style end tips. Baffles are 2.5" and are removable.

VT No.	Fits
30-3184	FLT 1995-up



30-0610

Bullet Muffler Set

- Non-removable baffle has a 3.5" diameter.

VT No.	Fits
30-0610	FLT 1995-up



3.5"



31-0598

30-0741

31-2136

Muffler Clamp and Bracket Set

- Hardware for various types of muffler fitments.
- Sold as a pair

VT No.	Item	Fits
31-0598	Hanger Bracket Set	FLT 1985-up
30-0741	4" Muffler Bracket Cover Set	FLT 1986-up
31-2136	End Clamp Set Custom application	



30-0243



30-0023

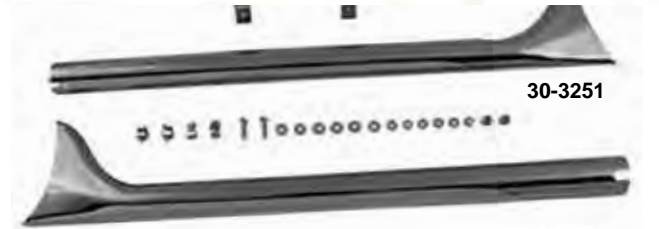

30-3251

31-0280

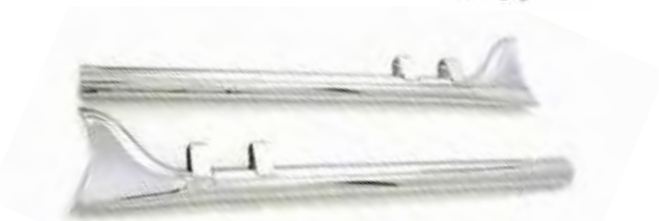

30-0427



30-0427 Installed

Straight Fishtail Kits

• Kits include pair of straight pipes and brackets.*Compatible brackets for 30-3251 sold separately, 31-0280. Fit FLT.

Chrome	Black	Length	Bracket Type	Fits
30-0243		29"	Mounting	1985-94
30-0023		29"	Mounting	1995-up
30-3251*		30"	Hanger	1995-up
30-0427	30-3026	30"	Hanger	1995-up
30-0781		32"	Channel	1995-up
30-0389		33"	Hanger	1995-up
30-0386		33"	Channel	1995-up
30-0816		33"	Channel	1995-up
30-0437		36"	Channel	1995-up
30-3027	30-3028	36"	Hanger	1995-up
Brackets for 30-3251				
31-0280*		Fishtail Exhaust Clamp Set		1995-up



30-3026



30-3026 Installed

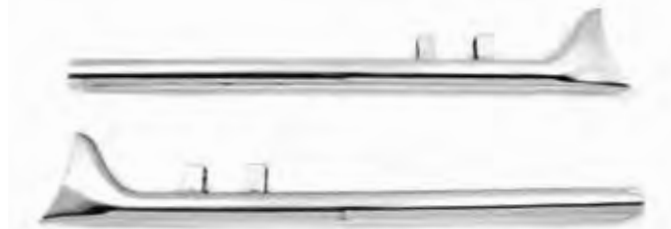

30-0389



30-0386



30-0437

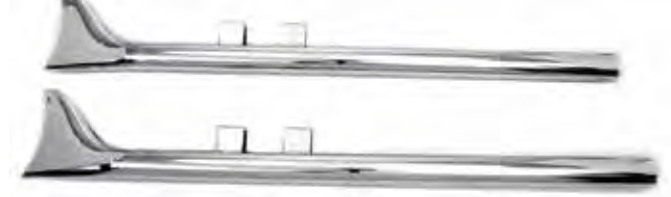

30-3027



30-3028



29-0044



2 into 1 Exhaust Header Set

- Includes front and rear header featuring turn out ends is welded with chrome covers.

VT No.	Fits
29-0044	FLT 2007-15, Chrome
29-0047	FLT 2007-15, Black



Dualie Straight Pipe Set

- Fits 1995-up FLT.
 - 2 pipes on each side, hot ride style, with baffles.
- VT No. 30-0847



30-3380



30-0214



Wyatt Gatling Chrome Fishtail Muffler Set

- 31" long fishtail style mufflers fit the existing clamps and hangers, and have a 3" body diameter. Muffler set features 4" waffle type baffle.

VT No.	Fits
30-3380	FLT, FLHT 1995-up
30-0214	FLT 1985-1994



30-0349



30-0435



30-0352

Chrome Dumper Straight Exhaust Pipe Set

- 2 3/8" outside diameter by 28" long, includes removable baffles.
- Pipe set has an original style channel hanging bracket.

VT No.	Fits
30-0349	FLT 1995-up
30-0435	FLT 1985-1994
30-0352	FLT 1985-1994

FLT Mufflers



30-0228



30-0227

1980-84 FLT-FLHT Muffler Set

- Available in turnout or fishtail design. Mufflers fit the existing clamps and hangers.

VT No.	Size/Type	Outside Diameter	Body Clamp
30-0227	31" Turnout	3"	31-9976
30-0228	30" Fishtail	2.5"	
31-2103	End Clamp		



Wyatt Gatling Tru-Dual Head Pipe Set

• Includes independent exhaust pipes for both cylinders, chrome full length heat shields and allows the use of OE style mufflers. Has 12mm oxygen sensor bungs. Fits 2010-up FLT.

VT No. 29-0077



29-1162

Chrome Dual Pipe Crossover Systems less Mufflers

• Feature intersection of left side cross over at rear pipe, 1 3/4" O.D.

VT No.	Heat shield	Year/Model
29-1162	30-0297	1980-83 FLT



29-1163



30-0307

Chrome Dual Crossover Exhaust Pipes

• Features intersection of left side crossover at rear pipe for Touring models. Pipes are 1 3/4" outer diameter.

VT No.	Fits
29-1166	FLT 1995-2006
29-1163	FLT 1985-1994
Heat Shields for Above	
30-0307	FLT 1985-2006



29-0079

Independent Dresser Dual Exhaust Set

• Includes independent exhaust pipes for both cylinders, chrome full length heat shields and allows the use of OE style mufflers.

• By Vance & Hines

VT No.	Fits
29-0079	FLT 1995-2008



30-0585



30-0581



Chrome Crossover Exhaust Header Pipes

• Steel and include heat shields and brackets. 30-0585 includes oxygen sensor.

VT No.	Fits
30-0585	FLT, FLHT, FLHR, FLTR 2007-2008
30-0581	FLT, FLHT, FLHR, FLTR 1995-2006

30-0612



32-1315



Chrome Crossover Exhaust Header Pipes

• Use original heat shields and clamps.

VT No.	Fits
30-0632	FLT 2010-up
30-0612	FLT 2009
Oxygen Sensor Harness for Above	
32-1315	FLH 2009



Jims Oxygen Sensor Wrench for removing and installing the 4 wire heated oxygen sensors. These sensors must be torqued to 14 ft-lbs. Lending to the design of this tool to be used with a 3/8" drive torque wrench. Fits 2010-up FLT.
VT No. 16-0382

29-1158



29-1156



30-0426



Chrome 2 into 1 Exhaust Header

VT No.	Fits
29-1158	FLT, FLHT, FLHS, FLHR 1996-2006
29-1156	FLT 1985-1999
Heat Shields for Above	
30-0426	FLT 1991-2006
30-0306	FLT 1985-1999

29-1198



30-0328



Chrome True Dual Exhaust Pipes

• Features independent exhaust pipes.

VT No.	Fits
29-1198	FLT 1999-2006
29-1167	FLT 1995-1998
Heat Shields for Above	
30-0328	FLT 1985-2006



Chrome Slash Cut Exhaust Drag Pipe Sets

- Slash cut ends and include mounting hardware.
- 30-3375 features O2 sensor bungs.

VT No.	Fits
30-3375	FLT 2007-2008
30-3157	FLT 1985-2006



Vance And Hines Independent Chrome Dual Exhaust Header

- Full length 2 1/8" heat shields.

VT No.	Fits
29-0081	FLT 2009-up
29-0079	FLT 1995-2008



Chrome Vance and Hines Power Dual Header Pipes

- The ticket to style, quality and performance.
- Features 12mm ports.

VT No.	Fits
30-1579	FLT, FLHT, FLHR 2010-up
30-1585	FLT, FLHT, FLHR 2009



Open Core Baffle Set

- For 2" Samson over & under open core drag pipes. Length is 9 7/8".

VT No.	Item	Fits
30-0351	2 1/4" Dumper Set	Replacement for straight pipe set



Baffle Ring Set

- Set is for Samson extreme series exhaust pipe set with a 2 1/4" diameter. Creates back pressure.

VT No.	Fits
30-0050	Custom for Samson Extreme exhaust pipes

Shovelhead Pipes for FLT



True Dual Chrome Exhaust Systems

- By Paughco
- Feature a single pipe for each side. Each pipe is independent, rear pipe for the left and front pipe for the right without intersection. Pipes have a 1 3/4" outside diameter. Order heat shield set separately. Does not include hardware. Uses 1 3/4" slip on mufflers

VT No.	Fits	Shield Set
29-1109	1980-83 Shovelhead FLT	30-0316



Hardware for Exhaust Pipes.

- All hardware is chrome finished

VT No.	Item	Fits
31-1250	Mount Bracket	FLT 1986-up
37-0977	2 3/8" Pipe Bolt and Spacer Kit	FLT 1985-up
31-2132	1 3/4" Pipe Clamp Set	Custom application



Chrome Drag Pipe with Slash Cut End.

- Fits FLT 1980-1984 FLT
- Includes mounting hardware for Shovelhead models.

VT No. 30-3208



30-1572



Big Radius Exhaust Drag Pipe Set

- Feature 2½" full header and muffler heat shield system, slash cut end caps, removable baffles and mounting hardware.

- By Vance & Hines

VT No.	Fits
30-1572	FLT 2010-2011
30-1556	FLT 2007-2008
30-1573	FLT 1999-2006



30-1578

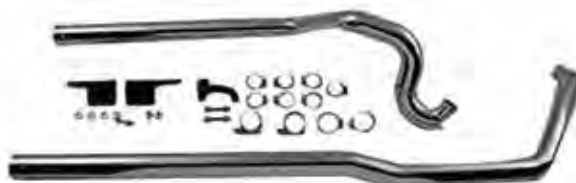

30-1531

Vance & Hines Chrome Exhaust Drag Pipe Set

- Include pipes, heat shields, caps, removable baffles and hardware.

VT No.	Fits
30-1578	FLT 2010-up
30-1577	FLT 2007
30-1531	FLT 1995-2006



30-1524

Vance & Hines Chrome Exhaust Drag Pipe Big Shot Dual Exhaust System

- Gives the bike a clean and uncluttered look.

VT No.	Fits
30-1524	FLT 1995-2006



30-0609

Wyatt Gatling Chrome Slash Cut

- Dual slash-cut crossover system includes headers, heat shields, brackets and slash down mufflers with removable baffles.

- *30-0609 fits models with O2 sensor.

VT No.	Fits
30-0631	FLT 2010-up
30-0621	FLT 2009
30-0609*	FLT 2007-2008
30-0608	FLT 1995-2008



30-0763



30-0588

Chrome Tru Dual Oval Crossover Exhaust Header System

- With oxygen sensor ports.
- Includes crossover kit with clamps.

VT No.	Fits
30-0764	FLT 2009
30-0763	FLT 2007-2008
30-0588	FLT, FLHT, FLHR, FLTR 1995-2006



30-0423



Exhaust Oxygen Sensor Plugs

• If you are doing away with your oxygen sensor, use this threaded plug in its place.

VT No.	Fits
30-0423	FLT 2004-09 18mm
30-0448	FLT 2010-up 12mm

32-6578



Oxygen Sensor Reducer Plug Set

• Allow the use of late type 12mm sensors in earlier exhaust pipes with 18mm sensor bungs.

VT No.	Fits
32-6578	Custom application

31-1069



Individual Header Pipe Components

• Clamp and bracket set, as well as specific pipe sections.

VT No.	Item	Fits
31-1069	Exhaust Clamp & Bracket Set	FLT 1995-2008
30-0637	Front Exhaust Header Pipe	FLT, FLHT 2010-13
30-0615	Front Exhaust Header Pipe	Custom application
30-0614	Rear Exhaust Header Pipe	FLT 2009-2013



48-0125



48-0157

Stainless Steel Tie Wraps

• For securing exhaust wrap to pipes.

VT No.	Length	Qty.
48-0125	14"	4
48-0157	11 ¹³ / ₁₆ " 300 mm x 7.9 mm x .25mm	10



16-1131



16-1132

Oxygen Sensor Removal Tool

• Easily removes or installs sensors on fuel injected models.

Fits FLT 2006-up	
VT No.	Application
16-1131	7/8" wrench or 3/8" drive
16-1132	3/8" drive for 12mm sensors



16-1385



16-1386

Oxygen Sensor Plug Thread Chaser Tool

• Used to repair damaged sensor threaded bungs in exhaust pipes.

VT No.	Size	Fits
16-1386	12mm	FLT 2010-up
16-1385	18mm	FLT 2007-2009



Oxygen Sensor Sealing Washer

VT No.	Year	MM
15-0081	2006-11	18
15-0012	2011-up	12



48-0126

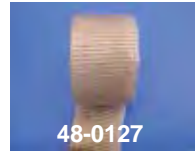

48-0127



48-0132

High Temperature Exhaust Wrap

Hot exhaust pipes bothering you? Don't sweat it, wrap your exhaust pipes in this heat resistant material. Material withstands continuous heat of about 1200F & 2000F intermittent temperatures.



48-0131

VT No.	Color	Size
48-0126	Black	25' x 2" x 1/16"
48-0127	Tan	25' x 2" x 1/16"
48-0132	Black	25' x 1.5mm
48-0131	White	25' x 1.5mm



Chrome Universal Heat Shields

• Mounting clamps included.

For 2¼" Pipes	
30-0120	4"
30-0474	6"
30-0121	10"
For 1¾" Pipes	
30-0122	10"
30-0123	12"
30-0124	18"



Chrome FLT Heat Shields

• Fit 1983-up models and fit stock heat pipe.

VT No.	Year	Type
30-3245	1992-up	Low, Right, Rear
30-3244	1983-up	Left, Top
30-0256	Clamp for Above, sold each	
30-1271	2009-up	Front Right
30-1272	2009-up	Rear Left



Chrome Replica Heat Shields

• Fit 1¾" to 2¼" exhaust pipes.

For custom application	
VT No.	Length
30-0221	5½"
30-0245	9"



Chrome Extended Front Heat Shield

• Covers exposed exhaust pipe adjacent to rider footboard. Uses stock mounting hardware.

VT No.	Fits
30-3371	FLT 1983-up, FLHTCUI 2002-2002



Chrome Custom Cut Universal Heat Shields

• Mounting clamps included.

Chrome	Black	Dia.	Length
30-0109	Perforated		9"
30-0106	Smooth	1¾"	7"
Skull			
30-3385	30-0466	2¼"	9"
30-3386	30-0467	2¼"	12"
30-0468	30-0471	1¾"	9"
30-0470	30-0472	1¾"	12"
Flame			
30-0118		1¾"	8"
30-0117		1¾"	11"
30-0481	30-0483	1¾"	9"
30-0482	30-0484	1¾"	12"
30-0473	30-0479	2¼"	9"
30-0478	30-0480	2¼"	12"



Chrome Custom Universal Heat Shield

• Available with grooved or flame pattern. Made from aluminum, mounting clamps included.

For custom application		
4"	6"	Style
30-0321	30-0362	Grooved
30-0364	30-0365	Flame

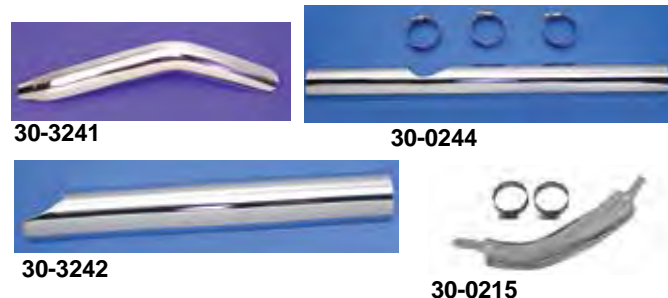

Chrome Stock Heat Shields

• Fit stock header pipes.

VT No.	Application	Fits
30-3241	Rear	FLT 1983-1997
30-0244	Lower	FLT 1981-1991
30-3242	Lower Right Side	FLT 1992-up
30-0215	Front	FLT 1981-1988



Kickstand for FLT



27-1694



27-1695



27-0540



27-1736



27-0987



13-9162



13-0182



13-0545



28-0400



28-0437



27-0539 shown with 27-0536 extension

27-0539

Chrome Kickstand Kit

- Includes jiffy stand, leg, spring, bracket and bumper stop.

VT No.	Fits
27-0539	FLT 1985-2000
27-0540	FLT 2001-2006
27-1007	FLT 2009-up
27-2101	Extension Kit, FLT 1991-up



27-1644



27-0536



27-1275



27-1440



27-0091

Kickstand Extension Kits

- Allow rider to more readily access side stand.
- Requires drilling 1/4" hole through kickstand.

VT No.	Model
27-1644	1984-up FLT, 1986-06 FXST, FLST
27-0536	1984-up FLT, 1986-06 FXST, FLST
27-1275	1991-up FLT, chrome
27-1440	1991-up FLT, black
27-0091	2007-up FLT

Chrome Kickstand and Springs

- To fit FLT stock as replacement.

VT No.	Year	Item
27-1694	1983-90	Kickstand with spring
27-1695	1991-06	Kickstand Leg Only
27-1736	1991-06	Kickstand with spring
27-0987	2007-up	Kickstand Leg Only
27-0998	2007-up	Kickstand with spring
Springs Only		
13-9162	1985-98	Chrome
13-0182	1999-06	Chrome
13-0545	2007-up	Chrome
13-0351	1999-06	Black
13-0350	2007-up	Black
28-0400	1985-2000	FLHR, FLHT, FLR Bumper Pad
28-0437	2001-2006	FLT, FLH Bumper Pad

Chrome Kickstand Tab Kit

- Includes washer, acorn nut, and tab.
- Fits 1985-06 FLT. VT No. 27-0546



27-0526



27-1525

Kickstand Mount Brackets

VT No.	Year	Item
27-0526	1981-08	Mount
27-1525	2009-up	Mount



Hex

Stock

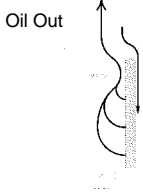

Oil flows in around the outer diameter, through the filter media and out passing by the magnet. The magnet captures particles less than 10 microns which could have escaped through the filter wall.

Magnetek™ Oil Filter.

- Feature a magnetic ring in center tower to trap particles less than 10 microns which could have escaped thru the filter wall.
- Available in stock style or with built in hex nut.

Hex	Stock	OEM	Fits	Length
40-0864	40-0852	63796-77	1980-up FLT	3.75"



35-6105

35-6106



35-6104

Oil Filters.

VT No.	Fits	Item
35-6105	2007-08, FLT, FLHT, FLHR, FLST	Fuel Filter
35-6106	1995-01 FLT, FLHT, FLHR	Fuel Filter
35-6104	2002-07 FLHT, FLT, FLHR	Fuel Filter
35-6108	2000-07 FLHT, FLHR	Line



16-0011

16-0098

DIY Touring Tool Kit

- For 1999-2013 models will fit in a kidney shaped tool box. Includes rider tools and service tools for the rider-mechanic.

VT No.	Fits
16-0011	1999-13
16-0098	2014-up



12-9990



TC-88 Super Pump.

- By Sifon utilizes an oversized highly efficient Geo Rotor design. Provides a 40% increase in pump volume and a 60% more scavenging volume. This high volume pump bolts into the stock location and includes O-Rings and mounting hardware

VT No.	Fits
12-9902	1999-06 FLT
12-9990	2007-up FLT



Motorshop™ Brand Filter Pack.

- Includes 6 pieces of individually wrapped and numbered chrome filters with 3" outside diameter and length as listed.

VT No.	OEM	Type	Length
40-0198	63782-80T	1982-84	2½"
40-0233	63798-99	1999-up	3¼"



Spin-On Oil Filters.

- Replaces stock units in chrome or black, Perf-form or V-Twin Brand in stock or with hex nut.
- Perf-form Tall Chrome Filter is ¾" longer than stock and will not fit fuel injected models. All filters listed are low restriction type.
- Length is 3.75"

Hex	Stock	OEM	Finish	Fits
40-0860	40-0708	63805-80T	Black	1980-98 FLT
40-0872	40-0709	63796-77T	Chrome	As Above



K&N Spin-On Oil Filters

- Available in chrome or black finish. Feature hex nut end for easy removal and installation, improved pressure relief valve, anti-drain back valve and heavy duty base plate with improved rolled seal.

Chrome	Black	Fits	Length
40-1710	40-1711	1980-98 FLT	3.75"

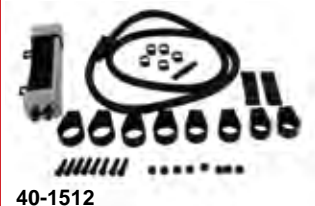

40-1512

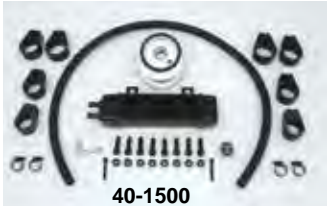

40-1500



40-2527



40-1520

Jagg Oil Coolers

- Features multipass oil flow configuration, specially designed turbulators in each oil passageway, and highly concentrated mini louvered air fins.
- Available in various mounting orientations.

Vertical Mount

40-1512	Chrome	FLT 1984-13 w/o ABS
40-1500	Black	FLT 1984-13 w/o ABS

Horizontal Mount

40-1520	Chrome	FLT 1984-up
40-2530		As Above includes adapter

Low Horizontal Mount

40-2528	Black	FLT 1984-2008
40-2527	Black	FLT 2009-up



40-0886



40-0885

Oil Temperature Dipsticks

- Features a hex design, lighted LCD readout, Fahrenheit or Celsius operation and a replaceable battery.

VT No.	Fits
40-0886	FLT 2007-2008
40-0885	FLT 1999-2006



40-0661

40-1274

40-1281

Custom Oil Dipsticks

- Chrome finish and designs as noted.
- For FLT

Style	1993-1999	2000-2006	2007-up
Smooth	40-0661	-	-
Skull	40-1274	40-1278	40-0624
Flame	40-1281	40-1273	40-0625



40-0471

Dual Oil Cooler Kit

- Includes dual tube vertical oil cooler with billet mount clamps measuring 10" long and 4 1/8" at top diameter.
- Stainless steel braided lines and 4 chrome seal ends included.

VT No.	Fits
40-0471	FLT 1998-up



Chrome Skull Air Cleaner Kit

- Includes bolts, brackets, and skull air cleaner cover.
- Air Cleaner ring holds outer cover in place on air cleaner.

VT No.	Fits
34-1506	FLT 1993-1999
Air Cleaner Ring	
34-0766	FLT 1993-2006 Except 1995-2001 EFI



34-0467



34-0625



Velo Air Cleaner Backing Plate Kit

- Includes one piece alloy backing plate, washable element, stainless steel breather kit with fittings, chrome breather filter and mounting hardware.

VT No.	Cover Size	Fits
34-1105	7"	FLT 1993-2007
34-1076	8"	FLT 1993-2007



34-0596



34-1241



34-0638



34-0640



34-0620



34-1070



34-0703



34-0702

Billet Scoop Air Cleaner

- Includes filter and mount brackets.
- Fits FLT 1993-1999

VT No.	Style
34-0703	Flame
34-0702	Smooth



Chrome V-Charger Air Cleaner

- Features scoop "blower" design and includes a built-in chrome screen and filter element. Kits come with bracket and/or integral bracket, and breather system. Air filter measures 2" wide, 4" inner diameter, and 5⁵/₁₆" outer diameter.

Full Kits

VT No.	Style	Fits
34-0467	Raised Bevel	FLT 1984-1991
34-0625	Smooth	FLT 1992-2006
34-0596	Smooth Bevel	FLT 1993-2007
34-1241	Raised Bevel	FLT 1999-2006 with Carburetor, FLT 2002-up with EFI

Air Cleaner Assemblies Only

34-0638	Raised Bevel	FLT 1990-up
34-0640	Flame	FLT 1990-1992
34-0620	Smooth	Custom application for S&S E carburetor
34-1070	V-Charger	Replacement

34-0637



8" Cycovator Air Cleaner

- Includes built-in breather bracket for S&S E models.
- Features 52 square inches of filter space.

VT No.	Fits
34-0637	FLT 1993-2007



34-1738

Mesh Air Cleaner Kit

VT No.	Style	Fits
34-1738	Skull	FLT 2008-up
34-1735	Skull	FLT 1993-2007
34-1742	Swiss Cheese	FLT 1993-up
Cover Only		
34-0276	Swiss Cheese	Custom application
34-0280	Skull	Custom application



34-1113



34-0655

From Sifton Air Power Air Cleaner Kit

- Includes die cast backing plate, filter, and breather canister.

VT No.	Item	Fits
34-1113	Air Cleaner Kit	FLT 1993-2007
34-0655	Teardrop Cover	FLT 1990-2006



Tear Drop Air Cleaner Assembly

- Features high flow element with billet mount bracket and plate. Kit includes all hardware to mount on Evolution and TC-88 models.

VT No.	Fits
34-0672	FLT 1993-2007



34-2122

50 mm Air Cleaner

VT No.	Item
34-2124	Elbow
34-2122	Kit



34-0700

Velo High Flow Air Cleaner Assembly

- Features a cast mount bracket with built-in breather and filter.
- Includes breather bolts and hardware to mount to 1992-up Evolution and TC-88 models.
- Order cover separately.

VT No.	Fits
34-0700	S&S FLT 1992-2005
34-1163	CV Air Cleaner Backing Plate



34-0566



34-1064



34-1028



34-0548

Round Air Cleaner Covers

• Feature embossed designs and center screw mounting. For CV type carburetors with stock backing plate.

VT No.	Diameter	Style	Fits
34-0566	7"	Smooth	FLT 1999-2007
34-1064	8"	American Motorcycle	FLT 1990-1999
34-1028	8"	V-Logo	FLT 1990-1999
34-0548	8"	Smooth	FLT 1990-1992



34-1053



34-0947

8" Round Air Cleaner Assemblies

• Filter element, backing plate, and cover included.

VT No.	Style	Fits
34-0407	Smooth Black	FL 1993-2007
34-1053	V Logo Chrome	FLT 1990-2007
34-0947	Smooth Chrome	FLT 1990-2007



34-0115

Air Filter Upgrade Kit

• Includes washable filter and studs.

VT No.	Fits
34-0115	FLT 1999-up



Chrome Air Cleaner Breather Snoot

• Fits FLT 1990-1992.
VT No. 34-1081

Wyatt Gatling Air Cleaner Assemblies

- Include integral breather system with bracket, mounting kit and air cleaner.
- Includes air filter element.

DIY easy install bolt-on assembly has no hoses to connect!
BT Assemblies fit 1993-2007 FLT

*Note: Fits 1990-92 FLT

Assembly	Air Cleaner	Shape	Style
34-1601	34-0406	Round	Black, 7"
34-1602	34-0764	Oval	Black, Mesh
34-1603	34-0746	Oval	Chrome, Mesh
34-1604	34-1206	Diamond	Billet
34-1605	34-1373	Round	Chrome, 7"
34-1606	34-0475	Oval	Chrome
34-1607	34-0742	Round	Black, Mesh
34-1608	34-0732	Round	Chrome, Mesh
34-1609*		Velocity Stack	Chrome
34-1611	34-0762	Round	Chrome, Drilled
34-1612	34-0763	Round	Chrome, Baby Moon
34-1613	34-1374	Oval	Chrome, Late Style
34-1614	34-0628	Teardrop	Chrome, Maltese
34-1615	34-1735	Round	Chrome, Skull Mesh
34-1617	34-1429	V-Charger	Chrome, Skull
34-1618	34-1742	Round	Chrome, Hole Pattern
34-1619*	34-1081**	Breather Snoot	Chrome
34-1620	34-1022	Teardrop	Chrome, Smooth
34-1621	34-0530	Teardrop	Chrome, Finner
34-1622	34-0511	Teardrop	Chrome, Flame
34-1623	34-0630	Teardrop	Chrome, Slotted
34-1624	34-0629	Teardrop	Chrome, Skull
34-1625	34-1020	Teardrop	Chrome, Live to Ride
34-1361		V-Charger	Chrome, Flame
34-1365	34-1334	Inverted	

*Note: Does not include filter element



Backing Plate

• Made of steel.

VT No.	Fits
34-1428	FLT 2008-up EFI
34-1044	FLT 1993-07 CV



34-0566 Installed on 34-0940

From Sifton

Performance Air Cleaner Kit

- Includes element, and backing plate.

VT No.		Fits
34-0941	Full Kit	FLT 1999-2007
34-0944*	Filter Kit	FLT 1999-2007
34-0940*	Filter Kit	FLT 1992-1999
34-1390	Backing Plate	FLT 1999-up

*Note: Does not includes cover



Sifton Air Cleaner Kit

- Includes a hi-flow "cycovator" filter with an integral metal backing plate for a direct bolt on application to carburetor and EFI models.

VT No.	Fits	Skull
34-1289	FLT 2008-up	34-1738
34-1290	FLT 1993-2007	



Velo Dish Air Cleaners

- Chrome dish and full flow filter with bracket that has integral breather passages and hardware.

VT No.	Size	Fits
34-0809	6"	FLT 1991-up
34-0807	8"	FLT 1993-up
34-0533	Cover Only for 34-0807	FLT 1993-up



34-0550



34-0555



34-0905

From Wyatt Gatling

7" Eagle Spirit Round Air Cleaners

VT No.	Fits
34-0550	FLT 1990-up
34-0555	FLT 1990-1992
34-0905	Replacement filter



34-1255

Cycovator Hi-flow Air Cleaner Kit

- Includes filter element, backing plate, integral bracket, breather bolts, gaskets, and hardware

VT No.	Item	Fits
34-1255	Full Kit	FLT 1992-2007
34-0098	Breather Bolts	FLT 1992-up Except 1995-01 EFI



Chrome Air Scoop

- Mounts on left side top motor mount studs. Air scoop offers improved cooling and acts as a horn cover.

VT No.	Fits
42-1010	FLT 1991-up



34-0732



34-0742



34-0501



34-0733



34-0711



34-1325

From Wyatt Gatling

Round Mesh Air Cleaners

- Element included.



VT No.	Style	Fits
34-0732	Chrome	FLT 1990-up
34-0742	Black	FLT 1990-up
34-0501	Chrome	FLT 1979-1989
34-1325	Black	FLT 1979-1989
34-0733	Chrome	S&S E Carburetor
34-0711	Foam Air Filter	For Above



34-0553

34-1041

34-1042

7" Round Air Cleaner

Includes with breather tube, backing plate, and foam element. For CV type carburetor.

VT No.	Item	Fits
34-1373	Kit w/o Brackets, logo	FLT 1993-up
34-1032	Kit w/o Brackets, smooth	FLT 1993-up
34-0553	Above with Brackets	FLT 1990-1992
34-1044	7" CV, Backing Plate	FLT 1990-2006
34-1041	7" Smooth, Cover Only	FLT 1979-1989
34-1042	7" V-Logo, Cover Only	FLT 1979-1989



34-0506



34-0906

From Wyatt Gatling

Chrome Round Air Cleaner

- With chrome mesh includes element, backing plate, and screws for a Bendix carburetor.

VT No.	Fits
34-0506	FLT 1979-1989
34-0906	Filter for dragton type housings



34-1095



34-1318

From Wyatt Gatling

New Era Air Cleaners

- Cleaners include chrome or black cover, filter, & backing plate.
- Fits FLT 1990-06 with CV Carburetor

VT No.	Finish
34-1095	Chrome
34-1318	Black



34-0802

New Era Air Cleaner Kit

- Includes chrome air cleaner, mounting bracket, and breather kit to fit stock Keihin carburetors. Filter sold separately.

Fits FLT 1993-2007	
VT No.	Finish
34-0802	Chrome
34-0937	Screen
34-0977	Foam



34-0475

Oval Air Cleaner Assembly

- For CV carburetors includes chrome cover, filter element, backing plate, and two cover screws.

- Screws for mounting to carburetor are not included.

VT No.	Fits
34-0475	FLT 1993-2007
34-1350	FLT 1990-2006, Backing Plate

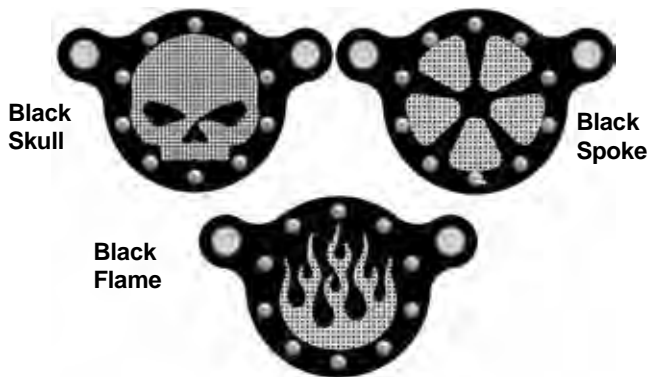

Black Skull

Black Spoke

Black Flame



Chrome Flame

Fits FLT 2008-up

Style	Black	Chrome
5 Spoke	34-0233	34-0242
Skull		34-0243
Flame	34-0235	34-0244
Fits FLT 2000-2007		
5 Spoke	34-0236	34-0245
Skull	34-0237	34-0246
Flame	34-0238	34-0247



34-0843



34-0844

Wyatt Gatling Chrome Skull Air Cleaner

- For CV carbs in black or chrome finish.
- Fits FLT 1993-up

VT No.	Style
34-0843	Chrome
34-0844	Black

34-0705

34-0661



Air Cleaner Breather Brackets

- Include bolts and chrome bracket.

VT No.	Year
34-0705	1993-07
34-0661	1992-07



34-2122 Installed



34-1236

Air Cleaner Kit

- Includes backing plate, air filter, breather manifold & hardware.

VT No.	Fits
34-1236	2002-2007
34-0943	1999-2007
34-2122	2008-up, Wyatt Gatling



34-0762

34-0763

From Wyatt Gatling

Chrome Air Cleaners

- Washable element

VT No.	Style	Fits
34-0762	Drilled	FL 1993-up
34-0763	Baby Moon	FLT 1993-up
34-0510	Drilled	FLT 1979-1989
34-0512	Smooth	FLT 1979-1989



34-0664



34-0657



34-0650



Chrome Tear Drop Air Cleaners

• CV type carburetors. Includes cover, backing plate, filter, rubber hose and hardware.

• Fits FLT 1999-2007

Finned	Smooth	Flame
34-0664	34-0657	34-0651
• Fits FLT 1992-1999		
34-0663	34-0656	34-0650



Chrome Tear Drop Finned Air Cleaner & Breather Kits

• Includes a chrome air cleaner assembly with a finned teardrop cover, chrome mount bracket, backing plate, and a breather kit with a black hose and breather unit.

• Fits FLT 1990-up

VT No.	Style
34-1022	Smooth 34-0916 filter, 34-1054 Plate, 34-0515 Cover
34-0511	Flames
34-0530	Finned, 34-0916 filter, 34-1054 Plate, 34-1560 Cover
34-0630	Slotted
34-0628	Maltese
34-0629	Skull and Crossbones
31-0430	Air Cleaner Mount Kit 1992-98 FLT

34-1528



34-1527



Siren Air Cleaner Assembly Chrome

• Includes chrome cover, backing plate and hardware.

VT No.	Fits
34-1528	FLT 2000-up
34-1527	FLT 1992-1999



Teardrop Air Cleaner Assembly

- Includes the filter and back plate for Keihin and CV carburetors, and also EFI.

VT No.	Fits
34-2123	FLT 1993-2006 Except 1995-2001 EFI



From Wyatt Gatling

Chrome Scoop Air Cleaner

VT No.	Fits
34-0985	Custom for S&S E and G carburetor



From Wyatt Gatling

Chrome Scoop Air Cleaner Cover

- *34-0455 includes cover, backing plate, and filter

VT No.	Fits
34-0455*	FLT 1990-up



Chrome Billet Sweeper Air Cleaner

- Fits CV carburetors. Order mount brackets separately.

VT No.	Fits
34-0668	FLT 1990-up

High Flow Air Sweep Cleaner Kit

- Includes a low restriction filter.
- Backing plate kit includes air cleaner element, gasket, and mounting hardware.

VT No.	Item	Fits
34-0822	Air Cleaner Kit	FLT 1993-up
34-0948	Air Filter Replacement for Stage 1 kits	
34-1182	Replacement studs for velocity air cleaner	



Sifton Dual Breather Kit

- Includes 2 vent canisters, banjo bolts, for Evolution and TC-88 models with necessary fittings. The breather is on the top of the canister.

VT No.	Brand	Fits
35-0441	Sifton	FLT 1992-up
34-0500*	Breather Bolt and Banjo Kit	FLT 1992-up



Chrome Oval Air Cleaner Cover

- Steel oval air cleaner cover has a chrome finish.
- Insert also available

VT No.	Application	Fits
34-0400	EFI	FLT 2000-up
34-0401	Carburetor	FLT 2000-up
34-0444	Insert for above	FLT 2000-2006



40-0346 installed on 34-1174



40-0346

Chrome Acorn Billet Canister Set

• Made from chrome billet aluminum and comes with bolts for Evolution and TC-88 models.

VT No.	Item	Fits
40-0346	Full Set	FLT 1992-up
40-0345	Single Canister	Custom for crossover metal tubes



31-0430

Crankcase Breather and Bracket Kit

• Fits CV carburetors. Includes two 3/8" x 16 and 1/2" x 13 threaded breather bolts. Fits 1992-98 FLT.

VT No. 31-0430

34-0772



34-0275



Chrome Panzer Air Cleaner

• Can be installed on CV or S&S Super E carburetor.

VT No.	Style
34-0772	Slotted
34-1880	Round Holes
34-0275	Air Filter

34-1882



Chrome Billet Air Cleaner Kit

• For CV and EFI models.

• Kit includes air filter element, chrome mounting bracket, and breather connectors.

VT No.	Fits
34-1882	FLT 1993-2007



Velo High Flow Air Cleaner Assembly

• Features a one piece alloy back plate with chrome eagle spirit cover. Includes element, breather kit and mount hardware. For fuel injected 2002-up FLT

VT No. 34-0804

Miscellaneous Air Cleaner for FLT

34-1286	Tapered Air Cleaner Assembly, FLT 1992-1999 FLT
34-1299	Hi Flow Chrome Air Cleaner with Skull, 2000-up FLT
34-0469	Chrome EFI Bracket, Fits 2008-up
34-0927	Backing Plate, 2008-up



34-0773
Installed



34-0773

Cycovator Air Cleaner Kit

• Forward mount air cleaner kit with tapered air filter

VT No.	Fits
34-0773	FLT 1993-2007 Except 1995-2001 EFI
34-1278	Replacement Filter



Eagle Spirit Air Cleaner Insert

- With gold inlay.

VT No.	Fits
34-0594	FLT 1999-up

34-0557



34-0558



Eagle Spirit Air Cleaner Inserts

- Gold or chrome inlay fit recessed area of round center screw type units.

VT No.	Finish	Fits
34-0557	Chrome	FLT 1984-1999
34-0558	Gold	FLT 1984-1999



34-0050



34-0051



From Wyatt Gatling

Skull Air Cleaner Inserts

- With a black raised skull for 7" or 8" air cleaners.

VT No.	Size	Fits
34-0050	7"	FLT 1999-up
34-0051	8"	FLT 1984-1999



From Wyatt Gatling

Air Cleaner Inserts

- Features gold, chrome, or black inlay on a round chrome or black backing plate.

- Fit 1999-2013 FLT

Style	Chrome/Chrome	Gold/Chrome	Black/Chrome	Chrome/Black	Gold/Black
Eagle	34-1431	34-1433	-	34-1432	34-1434
Skull	34-1435	-	34-1437	34-1436	-
Flame	34-1438	34-1440	-	34-1439	34-1441





40-0452

Sifton Chrome Dual Canister Set

- Includes dual canisters and hardware.

VT No.	Fits
40-0452	FLT 1992-up
40-0892	FLT 1999-up

34-0451 Installed



34-0451

Chrome Curved Air Cleaner Breather

- Includes steel bracket with breather bolts and tapered filter element with chrome 90° intake tube to face forward on CV carburetors
- Fits FLT 1993-2007 Except 1995-2001 EFI

VT No.	Item
34-0451	Full Kit
34-0771	Breather Only
34-0274	Air Filter Replacement



Carburetor Vent Fittings

VT No.	Angle	Notes
40-0581	Straight	All models, pack of 5
40-0532	90°	FLT 1979-1999, pair

42-0532 Live to Ride" medallion measures 3½" in diameter, has a chrome finish, and an adhesive backing.



35-8025



35-8029



35-8032

Chrome CV Carburetor Top replaces black plastic cover on 1990-up Big Twin models.

VT No.	Type
35-8025	Smooth
35-8029	Eagle Spirit
35-8032	Ball Mill



40-0436



40-0446



40-0449



40-0450

From Sifton Dual Breather Kit

- Chrome canister features enclosed breather filter and removable bottom cover for cleaning.
- Includes bolts, banjo tubes, and canisters.

VT No.	Item	Fits
40-0436	Full Kit	FLT 1992-up
40-0446	Breather Canister	
40-0449	Tube Kit	
40-0450	Straight Tube	



40-0588



40-0451

From Sifton

Chrome Mini Crankcase Breather Vent Set

- 40-0451 includes 2 canisters and banjo tubes with hardware.
- 40-0588 includes tie wraps and longer banjo bolts.

VT No.	Fits
40-0588	FLT 1992-up Except 1995-2001 EFI
40-0451	FLT 1992-up Except 1995-2001 EFI



35-0163

Chrome CV Carburetor Cover

Cover without choke cable mount.

VT No.	Style	Fits
35-0163	Yost	FLT 1990-2006

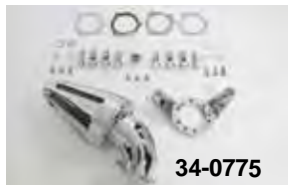

34-0775



34-1211



34-0671



34-0770



34-0673



34-0693

Chrome Cone Air Cleaner

• Features cone and integral breather mount bracket for vertical or forward mounting.

VT No.	Item	Fits
34-0775	Kit for Super E Carb	FLT 1992-up
34-1211	CV Carb Only	FLT 1993-up
34-0670	Horizontal	FLT 1993-2007 Except 1995-2001 EFI
34-0770	Breather Only	FLT 1993-2007
34-0671	Air Filter	Spike air cleaner breather
34-0673	Adapter Plate	Custom for S&S E Carburetor
34-0693	Adapter Plate	FLT 1993-2007



34-0076



34-0077

K&N AirCharger® Intake Kits

• Features a mandrel bent mirror polished intake tube and a chrome top conical shaped K&N High flow air filter.

VT No.	Fits
34-0076*	2001-07 FLT
34-0077	2008-up FLT

*Note: Fits fuel injected models only



34-1374

Oval Air Cleaner Assembly

• For CV carburetors which features late style shape chrome cover.

VT No.	Fits
34-1374	FLT 1993-2006 Except 1995-2001 EFI



Billet Air Cleaner Diamond Shape

• For CV carburetors.

VT No.	Fits
34-1206	FLT 1990-up



34-1340



34-0062 Kit with cover
Cycovator Air Cleaner Kit.

VT No.	Fits
34-1340	FLT 1999-2007
34-0062	FLT 1999-2007, Kit with cover



34-1340
installed

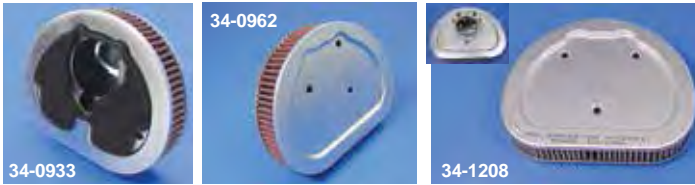

Replica Paper Air Filters

- Feature original shape and styling for exact fit. Washable construction.

VT No.	Fits
34-0933	1990-98 FLST, FLSTC, FLSTF, FLSTN, FLT/C/U, FLHT/C/P/U, FLHS
34-0962	1991-01 TC-88, carburetor, 2002-07 carburetor and electronic fuel injection
34-1208	2008-up FLT, FLH
34-0063	2014-up FLT



Air Filters

- Available in 3 types, K&N paper, Unifilter foam and Accel 2-stage foam.
- All have screen insert.

K&N	Accel	Uni-Foam	Fits
34-0736			2008-up FLT, FLHR
34-0576			2002-07 FLT
34-0579			1999-2001 TC-88 FLT with electronic fuel injection
34-0917			1995-99 80" Evolution with electronic fuel injection
34-1047			1990-99 80" Evolution
	34-0973	34-0976	1990-92 80" Evolution
		34-0911	1986-89 80" Evolution

Idle Adjustment Screws

- 35-0793 has flexible shaft, total length is 8". Kit includes flexible shaft, mounting bracket, and screw.



VT No.	Type	Fits
35-0169	Rigid Polished Polished carburetor idle adjuster screw. FLT 1993-2006	
35-0793	Flexible Chrome Skull Knob This flexible shaft idler adjuster screw kit has a skull knob with a chrome finish. The total length is 8". Kit includes flexible shaft, mounting bracket, and screw. FLT 1993-2006	



Electric Speedometer Assembly

- Features a digital odometer.

VT No.	Year	Model
39-0651	1995-03	FLHR
39-0610	As Above	Digital LED
39-0795	2004-07	FLHR
39-0597	2004-06	FLHR



Speedometer Visor Ring

- Fits FLH style speedometer.
VT No. 39-0224

Chrome FL/FLH Speedometer/Visor

- Fits all FL/FLH with large type speedometers. Attaches with double sided tape. Used for seeing speedometer in bright sunlight.

VT No. 42-0136

Speedometer Gauge Bezel.

- Chrome plated two piece design bezel clamps around any large style 5" speedometer. Fits 1968-84 FLH.

VT No. 42-1049



FLT Dash Console

- Includes tachometer and speedometer housing for 1981-84. KM/H.

VT No. 39-0398



Full Stainless Braid Covering with Clear Coat

Braided Stainless Steel Throttle and Idle Cable Sets

- Braided stainless steel with clear outer coating

VT No.	Length	Fits
36-0826	40"	FLHRCI 2002-2007, FLHRI 2002-2007
36-0773	43"	FLHR 1994-1995, FLHT 1990-1995, FLHS 1990-1993
36-0825	46"	FLT 1998-2001, FLHTCUI 1996-2001, FLCUI 1996-1996
36-8046	49"	FLHR 1996-2001



Black



Stainless

Front Wheel Drive Speedometer Cables.

Choose by application or by length and top nut size. Available in black vinyl, stainless or clear coated stainless.

Black Vinyl	Stainless	OEM	Length	Top Nut
1987-95 FLST Models				
36-2417	36-2428	67079-86A	34"	12mm
1987-95 FLHT-FLHTC-FLHTC-U Models.				
36-2418	—	67060-87A	39"	12mm
1980-86 FLT				
36-2412	—	67072-79A	40"	12mm
		67072-87B		
—	36-0127	Coated	40"	12mm



17-0595

Electronic Speedometer Sensor Unit.

VT No.	Years	Model
17-0595	1995-up	FLT

Braided Stainless Steel Clutch Cables

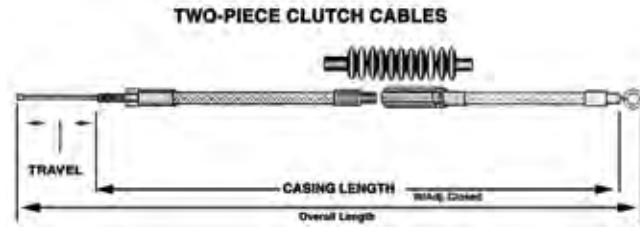

- Cables have braided stainless steel with clear outer coating.



VT No.	Length	Over Stock
36-0650	50"	
36-8048	62.69"	-
36-0519	63"	-
36-0558	65.69"	+2"
36-0559	66.50"	+4"
36-0560	69.25"	+6"
36-0518	75.625"	+8"
36-0561	74.50"	+10"
36-0556	75.25"	+12"
36-0557	79"	+16"
36-0867	72.81"	+6"
36-1160	62.51"	Stock
36-8058	55.44"	-
36-8059	62.69"	-



Vance and Hines Throttle Pak designed for throttle by wire, the throttle pak improves the responsiveness of your engine by eliminating the factory programmed electronic lag. Fits FLT 2008-up. **VT No. 32-1035**



Speedometer Drive Seal.

VT No.	OEM	Model
14-0966	67096-87	1987-95 FLT



Speedometer Drive Spacer replaces drive units.

VT No.	Year	Model
44-0370	1995-up	FLT

Speedometer Drive Unit

- Fits front wheel only with .750 axle hole. Use for right and left side as noted.

VT No.	OEM	Side	Length	Length	Fits
36-0804	67073-81	Right	Flat	.532"	1984-86 FLT
36-2450	67073-87A	Left	.421"	1.245"	1987-95 FLT
36-2453	67101-96	Left	.442"	1.248"	1996-99 FLT



37-9537

From Wyatt Gatling

Chrome Bolt Cap Kit

• Contain chrome bolt cap covers constructed of ABS plastic.

VT No.	Piece Qty.	Fits
37-9539	126	FLT 2009-up
37-9537	105	FXCW, FXCW 2009-up
37-9540	148	FLT 1999-2008
37-9526	75	FLT 2007-2008



From Gardner-Wescott

Engine Chrome Dress up Screw Kits

VT No.	Fits
37-8103	FLT 1999-2006 TC-88
37-8088	FLT 1991-1998
37-9300	1987-90 Evolution Big Twin FLT



From Gardner-Wescott

Chrome Allen Builders Fastener Sets

• The perfect combination of allen screws & acorn nuts.

VT No.	Fits
37-8098	FLT 1999-2006 TC-88
37-8095	FLT 1996-1998 Evolution
37-8090	FLT 1991-1995
37-0084	FLT 1984 Evolution 5-speed
37-0086	1987-90 Evolution FLT



Engine Dress up Acorn Bolt Kit

• For motor and transmission area. *All kits are chrome finished except 7918-G, which is gold finished.

VT No.	Fits
7926	FLT 1999-2006 TC-88
7918-G*	FLT 1985-1986 Evolution 5-Speed
7918	FLT 1985-1986 Evolution 5-Speed
7931	FLT 1996-1998
7930	FLT 1992-1995
7929	FLT 1987-1991



Assorted Chrome Screw Kits.

For FLT 2007-up

VT No.	Head Style	Application
2400-12	Allen	Oil Pan Mount
2532-14	Acorn	Transmission Side Cover
2401-15	Allen	Transmission Side Cover
2534-19	Acorn	Primary Cover
2402-18	Knurled Allen	Primary Cover
2402-18T	Knurled Allen	Primary Cover
2403-22	Allen	Engine Mount
2533-6	Acorn	Transmission Shifter Cover



Chrome Polished Allen Head Show Bike Kits.

Model	VT No.	Year
FLT	1009-P	1979-84
FLT	1019-P	1987-91



Cam & Primary Cover Chrome Screw Sets

• Include transmission, chain, clutch or derby provided where applicable. By Gardner-Wescott.

VT No.	Fits
37-8502	1987-06 FLT 5-Speed
37-8503	1985-86 FLT 5-Speed



Chrome Velva Ride Engine Stabilizer

• Features a steel body with plunger and urethane dampener that creates a mini shock absorber.

VT No.	Fits
31-1983	FLT 1979-2008



Chrome Front Engine Mount Stabilizer

VT No.	Fits
31-0286	FLT 1979-2008



Chrome Front Engine Mount Assembly

• Includes bracket, link, and ISO mount with hardware.

VT No.	Fits
31-0625	FLT 1979-2007



31-1975

31-0900



31-0682

Urethane Engine Mounts

• Replace stock on all Big Twins with rubber mounted engines.

The formulated compounds enhance compression and rebound dampening properties for a 20% reduction in vibration.

• For FLT 1979-2008

VT No.	Brand	Finish
31-1975	V-Thunder	Black
31-0900	Sifton	Black
31-0682	Sifton	Chrome

31-1278



Front Mount Brackets for 2008-up FLT.

VT No.	Finish
31-1277	Chrome
31-1278	Black



31-1274

31-1983

Front Engine Limiter Kit

• Dampens extreme movement on front motor mount cushion.

VT No.	Fits
31-1274	2009-up
31-1983	1970-08



ISO Mount

• Replaces stock on all Big Twin rubber mounted engines. The mount plate is billet aluminum with a polyurethane bushing assembly.

VT No.	Fits
31-0905	FLT 1978-2008



FLT Stabilizer Bar Chrome

VT No.	Fits
31-0010	FLT 2009-up



31-0256



31-0257

FLT Chrome Top Engine Mounts

• Feature two piece design, to be installed on rubber mounted engines in stock or custom solid mount frames.

VT No.	Fits
31-0256	1980-83 Shovelhead
31-0257	1984-98 Evolution

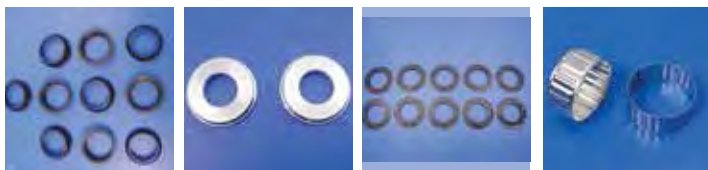

44-2039 44-2040 44-2041 31-0444



31-0452 44-0883 31-0442 31-0443



44-2061 31-3986 44-0887 44-2062



44-0882 44-2040



44-1984 44-2052

FLT/FXR Swingarm Rebuild Parts

VT No.	OEM	Year	Item
44-2039	47510-80	1980-01	Plastic Retaining Ring
44-2040	47511-80	1987-01	Spacer
44-2041	47513-80	1987-01	Nylon Washer
31-0444	47538-79	1979-01	Bushing Ring
31-0452	47556-81	1979-01	Bushing Assembly
31-3986	47553-79	1979-81	Mount Bushing, pair
31-0442	47564-82	1982-86	Mount Bushing, each
31-0443	47564-86A	1987-08	Mount Bushing, each
44-2061	47584-09	2009-up	Mount Bushing Set
44-2042	47491-89	1989-01	Cupwasher, 5 pack
44-0887	47606-02	2002-08	Nut Set
44-0883	9208	2002-up	Bearing Set
44-0882	47491-02	2002-10	Washing Set
44-2054	47505-02	2003-10	Shaft
44-1991	47492-89A	1989-01	Shaft
44-1984	47515-82A	1982-88	Shaft
44-2052	47515-80A	1980-81	Shaft
44-2062	47606-09	2010-up	Nut
37-0538	67865-89		Plug, Chrome



Iso-Mount Swingarm Pin Kit

- Includes Iso sleeves, pin and side bushings for 1993-2010.

VT No.	Item
44-2063	Kit
44-0853	Shaft



44-2058

44-2044

44-2055

44-0982

Swingarm Mounting Kit

- Includes two bushing assemblies, two spacers, two plastic retainer rings, two rubber isolators and pivot shaft with locknut and all parts required to mount transmission and swingarm to pivot block.

- Will work with stock or aftermarket rubber mount swingarm frames for FLT-FXR models.

VT No.	Year
44-2058	FLT 1980-81
44-2044	FLT 1982-01
44-2055	FLT 2002-08
44-2059	FLT 2009-10
44-0982	FLT 2011-up



44-0941

1982-02 FLT-FXR Kit

updated with spherical bearing. All are pieces included for ease of installation.

- updated Design
- Rubbers included
- Controls lateral and torsional movement at pivot point
- Close tolerance spherical bearings included

VT No.	Item
44-0941	Kit
44-0960	Spacer Set



42-0030

Chrome Swingarm Mount Kit

- Includes right and left chrome pivot caps, chrome passenger footboards mounts and chrome passenger footboards with rubber pads for Touring.

VT No.	OEM	Fits
42-0030	47850-88T	1982-89
42-0114	47850-90T	1990-95

(4) Chrome Allen Mount Screw



44-2060

Swingarm Kit

- Includes 2 offset steel bushings and 2 alloy washers.

VT No.	Fits
44-2060	FLT 1980-2008, FL 1980-2008, FLHTC 1980-2008



Nylatron Swingarm Bushing Kit

- Four piece bushing set replaces swingarm bearings and stabilizes swingarm rubber mounts.
- Order pin separately. Order (31-3986 or 31-0443) frame mount bushings separately.

VT No.	Fits
44-0671	FLT 1982-2002, FLHT 1982-2002, FLHR 1995-2002



51-0992



51-0994

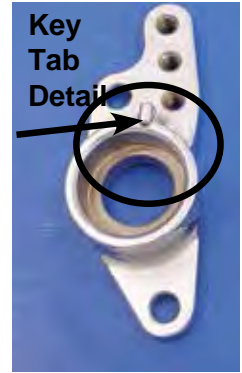

51-0992 will retro fit 1982-02 to accept foot pegs and foot board mounts on the right and left side.

*Note: Key tabs to secure rubber bushings.

Chrome Pivot Mount End

- Fit years as noted.

VT No.	Year
51-0992	1982-06
51-0994	2007-08



Swingarm Iso Mount Pin Kit

- Includes pin and outer support bushings with steel side plates for upgrades.

VT No.	Fits
44-2064	1993-02 Touring



39-0571



39-0606



39-0221

Chrome Dash Covers and Extension

• For use with shorter seats.

VT No.	Item	Fits
39-0571	Dash Cover	FLT 2003-2007
39-0606	Billet Dash Cover	FLHR 1994-2000
39-0221	Extension	FLT 1996-up models with a shorter seat



Speedometer Adapter Ring

- Adapts to late model speedometer into FLH style steel dash cover.
- FLH Dash is shown with 39-0130 adapter ring installed, adapter ring must be affixed with an industrial adhesive for a leak proof seal.
- VT No's 39-0124 and 39-0192 include chrome ring and bracket to mount electronic speedometer in FLH style dashes.

VT No. 39-0130



39-0461



39-0460

Dash Stash Box

• Fit 1997-2007 FLHT with a short nose seat.

VT No.	Finish
39-0461	Raw
39-0460	Chrome



38-0432



38-1284

Console Fuel Door Push Button

VT No.	Finish
38-0432	Chrome
38-1284	Black
38-0434	Chrome, Key Operated



39-0654



38-0441



38-0442



38-0430

Fuel Console Doors

VT No.	Years	Finish
39-0654	1992-08	Chrome
38-0441	2009-up	Chrome
38-0442	2009-up	Black
38-0430	1992-08	Black Skull



5 Gallon Stretch Gas Tank

For FLT models including FLHT, FLHR and FLTR models without fuel injection.

- Tanks include custom console to cover OEM gauge sending unit.
- Use standard bung right and left caps and petcock.
- Shorter seat may be required.



VT No.	Year	Type	Gallon
38-0255	1997-03	Carburetor	5
38-0256	1989-96	Carburetor	5
38-0475	1996-06	Carburetor	7
38-0473	2003-07	EFI	7
38-0474	2008-up	EFI	7
38-0925	2008-14	EFI	6.6
39-0571	2003-07	Dash Panel	





38-0186
Bobbed Tank Kit

- For FLT models features a one piece 4 gallon design tank which includes chrome bung style caps and hardware for installation.
- Kits for 1980-99 include a chrome cast dash, 5 lamp dash base and a 6 post bobbed type key switch with a 2240:1 ratio speedometer and front wheel drive cable. Requires the use of solo seat or FXR style seat for installation. Models for 1980-85 require drilling for rear mount.

VT No.	Item
38-0186	Kit
38-0298	Tank Only
2530-6	Mount Bolts



Magneti Marelli Fuel Injection to Carburetor Petcock Conversion Fitting Set. Converts all 1995-01 Big Twins equipped with Magneti Marelli Fuel Injection System to carburetor system. Can be used with any 22mm petcock. Fits 1995-01 FLT models.
VT No. 35-0751



Pewter Emblems with adhesive backing.

VT No.	Size	Style
48-0490	4" x 3"	Skull with sickle
48-0491	3" x 1"	5 Skulls
48-0492	2" x 3"	Grim Reaper
48-0493	1.5" x 2.5"	Skull
48-0494	2.5" x 2.5"	Maltese Cross with Skull
48-0495	1.5" x 1"	Skull
48-0496	3" x 1"	Winged Skull
48-0497	5" x 2"	Bat Wing



35-1459

Tank Petcock Valve

- Shut off drain for carburetor.

VT No.	Fits
35-1459	FLT 2002-2006



37-9329

Fuel Valve Petcock

• With male thread features a natural finish. Includes nut and screen. For 1340cc models. Designs are made for a seated position on the motorcycle with the hose outlet facing a direction to ease fuel line hookup. Features two filters as original. Fits 1995-2001 FLT. OEM # 61338-94D
VT No. 35-0222



37-9329

Custom Tank Mount Bolt Sets.

37-9329	1998-up FLT
---------	-------------



Delphi Fuel Injection to Carburetor Conversion Fitting Set includes gas tank fitting to eliminate Delphi fuel injection and use a carburetor and late style petcock. Fits 2002-up.
VT No. 35-9353



35-0748

Adapter Bushing allows use of carb type petcock on electronic fuel injection models.

VT No.	Model
35-0748	FL



48-0493 Installed



48-0493 Installed



Headlamp Cowl for FLT

TOURING

24-0318



33-0080
Installed



24-0355



24-0267



33-2134
Installed



24-0355



33-0547
Installed



33-0547

13-0983



Frenched Headlamp Ring fits 83-up models VT No. 33-0547

Chrome Headlamp Cowl Kit

- Includes right and left sides.
- Fits 1986-13 FLT models to update to Road King style.
- Includes housing assembly, handlebar top cover, headlamp assembly, top and rear trim strip and mounting hardware.

VT No.	Item
24-0355	Complete Housing Assembly Kit, 1986-13 FLT
24-0318	Complete Assembly with lamp, chrome upper fork leg covers and chrome fork air baffle
24-0267	Housing Set Only for stock FLHR



33-1174



33-0808



33-1174
Installed

Contoured Headlamp Mount Rim

- Fits 1983-2013 FLT, 1994-up FLHR.

VT No.	Type
33-0080	Contour
33-2134	Stock
33-0547	Frenched
13-0983	Clip
33-1174	Billet
33-0808	2014-up



33-2004



24-0227



31-0499



37-0997



31-0247



31-0246

Parts Available Separately

33-2004	Headlamp Assembly
24-0227	Upper Chrome Fork Cover Set
31-0499	Spot Lamp Bracket
31-0246	Top Trim Strip
31-0247	Rear Trim Strip
37-0997	Speed Nut



Chrome Handlebar Riser Cover. Fits 1993-up FLHR. VT No. 24-1045



Chrome Billet Fork Lock Cover with raised black skull design. Fits 1994-2008 FLHR. VT No. 42-0135



Handlebar Cover allows use of bars with built in risers to fit Road King models with cowl assembly. VT No. 24-1063



24-0286

24-0247



24-0287



24-0260

Chrome Headlamp Housing Kit

• Fits 1980-86 FLT, 1983-85 FLHT-FLHTC and 1987-92 FLHS includes chrome ABS headlight housing, 7" H-4 lamp assembly with rim, upper fork covers (which can be installed without disassembly of fork) and chrome fork air baffle.

VT No.	Model
24-0286	1980-86 FLT, 1983-85 FLHT
24-0287	1987-92 FLHS

Chrome ABS Headlamp Housing Only.

• For conversion order internal kit 33-2070 separately. Use on all 1980-92 FLT, 1983-85 FLHT, FLHTC, 1987-92 FLHS. Available with or without throttle cable hole. VT No. 24-0247 has hole for cable.

VT No.	OEM	Type
24-0247	67704-83	With throttle cable hole
24-0260	67680-91	Without throttle cable hole



7" H-4 Headlamp Assembly

• Without chrome outer rim. Headlamp is attached to a black housing.
VT No. 33-3041



Chrome Front Fork Air Baffle

• Fits 1980-up FLT/FLHT models, does not fit 1998-up FLTR. Replaces 58520-79TC.
VT No. 24-0272



24-0228

24-0229

Chrome Upper Fork Covers

• Unique 2 piece design which allows easy installation over stock covers without fork disassembly or removal.
• All components are chrome plated steel.

VT No.	OEM	Fits
24-0228	68064-94	1980-95 FLT, 1987-93 FLHS
24-0229	68063-94	1986-95 FLHTC, FLHTCU



33-1008



33-1100



Wyatt Gatling 7" LED Headlamp Assembly

• Features six LED's on both sides of the bulb. Bulb features a parabolic lens design and the LED's acts as running lights or turn signals.

VT No. 33-1008



33-1100

Dual LED Headlamp Unit

• Includes two LED daylight headlamps mounted onto a backing plate for easy installation, features a housing with reflector

VT No. Finish

33-1100 Chrome

33-1101 Black



33-1044

7" LED Headlamp Unit.

• Features black shaded reflector. *Note: LED lamp unit includes built in DRL (Day Running Light). Order adapter ring 33-0080 separately for FLH applications.

VT No. 33-1044



33-1447

H9 High Beam Headlamp Replacement Bulb.

• Fits FLHX, FLHXS, FLHR 2014-up. OEM # 67717-01.

VT No. 33-1447



33-1184

4.5" LED Spotlamp Assembly is 12 volt, 55/60W, and features a H4 bulb. Fits 1960-up FL.

VT No. U/M

33-1184 Each

33-1545 Set



Headlamp for FLT

Chrome	Black	
33-1104	33-1105	1994-13 FLT
33-1106	33-1107	2014-up FLT



33-1016

12 Volt Spotlamp Assembly with mount spacer and clear bulb. Sold as pair unless noted.

VT No. Type

33-1016 4.5" LED, 1979-up FL, each

33-1732 4.5" LED, 1979-up FL, set



All Frames fit standard 4" x 7" size unless noted.

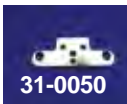

31-0050 Installed

Billet Chrome Tail Lamp & Plate Holder

• Include mounting bracket feature LED. Rail mount for 1997-up FLT models. **Note:** 42-0987 does not have a lamp.

VT No .	Style	Item
33-0388	Plain	LED
33-0387	Skull	LED
33-0389	Diamond	LED
33-0392	Slice	LED
42-0987	Spade	None
31-0050	Replacement Mounting Bracket for Above	



License Plate Bar Eliminator Bracket Set

• Allows the license plate support tube to be removed and will still allow the stock saddlebags support brackets to be used. Sold in pairs.

VT No. 31-1268



Chrome License Plate Frame Kit

• Fits 7¼" x 4" standard plates.

VT No. 42-0066



42-9985



Marker Lamp Light Bar Set

• Includes four bullet lamps to fit 1997-08 Touring with stock rear fender rail and license plate mount. Fits 7¼" x 4" standard plates.

VT No	Item
42-9985	Marker Lamp Light Bar Set
31-1756	Bracket



31-0780 Installed



Lay Down License Plate Bracket

• Fits 1997-up Road King models.

VT No	Item
31-0780	Plate and Bracket
42-1069	Plate Only



31-1006 Installed

Billet License Plate Bracket

• Mounts below tail lamp in existing holes, by removing the stock turn signal bracket on 1991-08 FLT, 1978-84 FLH.

VT No.	Item
31-1006	Plate Holder
31-1268	Bracket Set



33-0172

4 1/2" Chrome Bullet Style Spotlamp Trim

- Held in place by existing headlamp bulb and rim.

VT No. 33-0172



33-0546 Installed



33-0551

Spotlamp Trim Ring Set

- Allow installation of visors on 1987-up models, sold as pair.

VT No.	Item
33-0551	Rings
42-0202	Visors, pair



33-0811 Installed



Chrome 12 Volt Spotlamp

- Includes with mount spacer and amber running lamp.
- Fits 1979-up FLT.

VT No.	U/M
33-1282	Each
33-1735	Pair



33-0811

Spotlamp Dress Ring

- Features a recessed "frenched" deep design. Also available with built in visor.

VT No.	Type
33-0546	Frenched
33-0811	Frenched with visor



33-0066



33-0073



33-1016



33-0903



33-0152



33-1304



33-1190



33-0098

Spotlamp Bulb Kit

• Fits 1996-up FLT-FLHT models

VT No.	Item
33-0152	Bulb Set H-3
33-1304	881 12 Volt
33-1190*	881 12 Volt LED
33-0098**	Bulb Set with harness

*Note: LED type bulb set bright white beam 6000k.

**Note: Includes harness that allows spotlamps to remain on when high is used.

33-1459 Bulb Set for 4½" spotlamps, 12V/27W 8814 T3 bulbs.

33-0973 4½" Halogen Beam Bulb, 2006-up

33-1042 Inner Mount Ring Set

33-1110 Chrome Shell and Wire Kit

33-1320 Screw and Nut Set



33-0903 Installed

12 Volt Spotlamp Assembly

With mount spacer and clear bulb. Sold as pair.

VT No.	Type/Year
33-0066	1979-up FLT, Chrome
33-3051	1979-up FLT, Black
33-0073	Chrome, blue, 1979-up
33-1016	LED/1968-up
33-0903	2006-up Touring
33-0634	69227-04A, 1996-up





Spotlamp Bracket



31-0927



31-1343



31-1027



31-1347



31-1349

Spotlamp Brackets. Clamp on style for engine guards, pair.

VT No.	Type
31-1347	Chrome, Fog Lamp Clamp 68000170
31-1348	Black Fog Lamp Clamp 68000142
31-1349	Chrome Fog Lamp Clamp 6800017
31-1350	Black, Fog Lamp 68000141

Spotlamp Kit

• Fits 1996-up FLT-FLHT models.

Chrome	Black	Item
31-0927	31-1343	Bracket Set 2014-up
31-1027	31-1344	Bracket Set 1996-13



31-0499

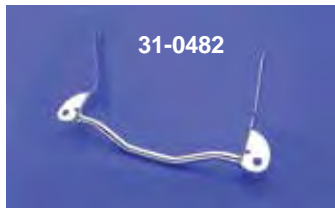

31-0482

Chrome Spotlamp Mount Bracket is one piece type. Use VT No. 33-0010 Spotlamp.

VT No.	Fits
31-0482	1986-up FLHS
37-0552	Spacer for Above
31-0499	1994-01 FLHR, 1997-up FLHT

Brackets	
31-0927	2014-up
31-1027	1996-13

*Note: Includes brackets which mount to lower pinch bolts.



31-0311



31-0310

Chrome V-Style Spotlamp Brackets

• Replace stock bracket.

VT No.	Year	Model
31-0311	1986-2001	FLST-FLSTF
31-0310	1994-up	FLHR



31-0830

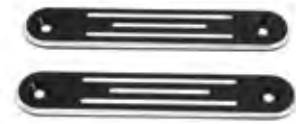

31-0828

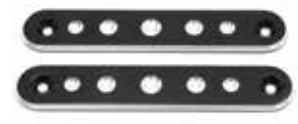

31-0829



31-0831



31-0833

Spotlamp Eliminator Bracket Set.

Chrome	Black	Type
31-0830	31-0828	Ball Milled
31-0831	31-0829	Drilled
Carbon Fiber		
31-0833		Ball Milled



Spotlamp Bracket Covers feature textured surface and stepped design. Fits all 1996-13 FLT models. Replaces 68613-01.
VT No. 42-0606



33-1440



33-1444



33-1441



33-1445



33-1443



33-1446



31-0962

Chrome Turn Signal Bracket Set

- Mounts as stock. Mount holes are 6 $\frac{3}{4}$ " center to center.

VT No. Fits

31-0964 FLHR 1997-up Road King Headlamp Nacelle, FLT 1997-13

LED Turn Signal Sets.

Chrome	Black	Item
33-1440	33-1444	Combo Tail/Turn Signal Lamp 1989-up FLT
33-1441	33-1445	Front Turn Signal, Dual Function 1996-up FL, Smoke Lens
33-1443	33-1446	Rear Turn Signal, Signal Function 1996-up FL, Smoke Lens



Chrome Turn Signal Block Off Bevel Style Plates

- For use when front fairing mounted on the turn signals are removed or relocated.

VT No. Fits

31-0075 FLTR 1998-up





Rear Signal Mount



31-1235

33-3035



33-1175

Chrome Rear Turn Signal Bar

1999-up FLT	
33-1288	LED
33-3035	Bulb
31-0865	Bracket Only
31-1235	Bracket
2011-up	
33-1049	LED
33-1000	Bulb

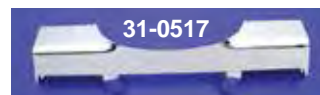

Chrome Rear Directional Signal Bar

• Constructed of formed and welded steel which offers the greatest strength against vibration.

VT No.	Fits	Length
31-0494	1974-84 FLH 1991-up Road King	13"
31-0517	1985-90 FLT-FLHT	8 $\frac{3}{4}$ "
31-0495	1974-84 FL	13"

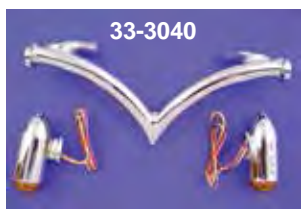

V-Shape Rear Turn Signal Kit

• Fits FLT. Includes red/amber LED bulb lamps.

VT No.	Item
33-3040	Kit
33-0762	LED Lamp Set

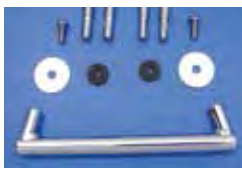

Chrome Round Turn Signal Bar

• Include hollow bolts to mount custom turn signals. Fits 1991-04 FLT.

VT No. 31-0329

Revox Turn Signal Bar

• Fits 1986-up FLST, 1991-08 FLT, 2009-13 FLH.

Chrome	Black	Lens Color
33-1175	33-1176	Amber
33-1177	33-1178	Smoke

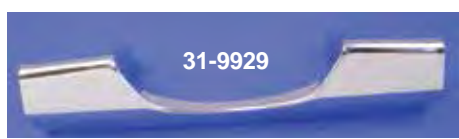
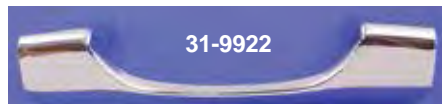
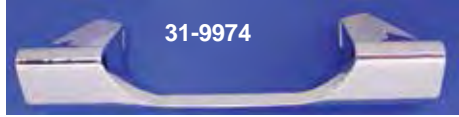
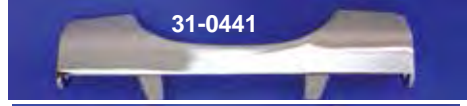

VT No. 31-9922 Installed

Chrome Rear Turn Signal Mounts.

*Note: Polish.

VT No.	Length	Model
31-3987	13"	1985-90 FLHS-FLT
31-3935	9"	As Above
31-0441	8 $\frac{1}{4}$ "	1985-90 FLHS-FLT
31-4006*	12 $\frac{7}{8}$ "	1974-84 FLH, 1991-up FLT-FLHS-FLHR
31-2098	12 $\frac{7}{8}$ "	As above
31-9974	9"	As above
31-9922	8 $\frac{1}{4}$ "	As above
31-9929	10"	As above



Chrome Low Boyz Turn Signal Bar

• Replaces 68430-89 and is threaded to accept stock turn signals and mounts to license plate bracket holes.

VT No.	Item	Length
31-0206	Bar	12"
31-0776	Bar Kit	7"
37-0561	End Nuts	
31-1289	Bar Kit	9.72"

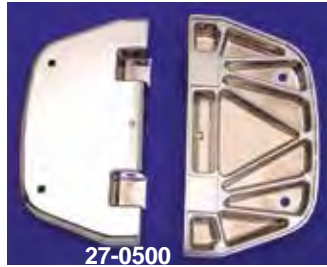

27-0500

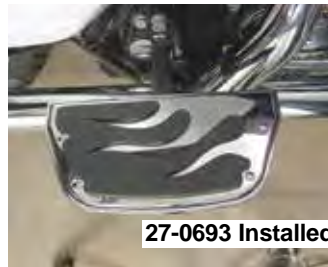

27-0693 Installed

27-0815



27-0803



Chrome Replica Passenger Footboard Set

• Fit all OE style brackets and will accept rubber pads from 1986-up.

VT No.	Item
27-0969	Board Set Only
27-0500	Board Set Only
27-0693	Flame
27-0815	Board/Rubber
27-0803	Pin Set, Fits OE
27-0864	Pin Set for 27-0500

27-0022



Slasher Style Chrome Billet Passenger Footboard Set

• Features CNC machining, removable anti-vibration dampers and a unique shape. Fit 1984-up FL. VT No. 27-0022



27-1523 Installed



27-1523

Passenger Peg Mount Kit

• Mounts to rear existing mount to accept a male peg set. Kit allows 360° rotation to raise or lower peg height. Fits 1993-up FLT models.

VT No. 27-1523



Black Rear Passenger Footboard Set

• Without rubber inserts. Fits 1993-up FLT.

VT No. 27-1761

27-0834



Billet Rear Passenger Footboard Set.

• Fit 1986-up FLT models. Chrome insert features inlay rubber pad.

VT No.	Type
27-0834	Rail

27-1549



27-1458



27-1456



Streamline Passenger Footboard Set.

VT No.	Item
27-1549	Board Set, Chromr
27-1458	Board Set, Black
27-1456	Board Set; order pins separately
28-0990	Right Rubber
28-0991	Left Rubber
27-1984	Chrome Set without rubber
27-1135	Rubber Inserts
27-0750	Board Set, Chrome

27-1599



Chrome Passenger Footboard Covers

• Fit fold up type factory cast boards. Includes 2 covers with 4 self tapping screws.

VT No.	Item
27-1599	Cover Set, 1986-up

27-0229



27-0703



27-1550



Passenger Footboard Set.

• Fit 1993-up FLT.

VT No.	Style
27-0229	Rubber Pad
27-0703	Diamond
27-1550	Stock



27-0561 Installed



27-0561



27-1522 Adjustable



27-1522



27-1523

Rear Passenger Footboard Mount

• For 1993-up models FLT, FLHT and FLHS. **Note:** Order footboards and mats separately.

Chrome	Black	Year	Note
27-0561	27-0832	1993-2009	Non-Adjustable
27-1522	27-0831	1993-2009	Adjustable
27-1523		1993-up	Passenger Footpeg Mt Kit
27-0964	27-0977		Streamline Board Only

27-0854



27-1739



FLT Chrome Passenger Footboard Kit.

Footboards fold up when not in use. Kit includes footboards and mounting hardware. Fits all 1993-up FLT models.

VT No.	Footboards
27-0854	Stock
27-1739	Streamline



51-0998



51-0853

Passenger Footboard Sets with Swingarm Mount Kit

• Includes right & left side chrome pivot caps, passenger footboard mounts and passenger footboard with rubber pads.

VT No.	Footboard Style	Fits
51-0998	D-Shaped	FLT 2007-2008
51-0853	D-Shaped	FLT 1982-2006
51-0867	Mini	FLT 1982-2006



1993-up FLT Rear Footpeg Kit

• Includes chrome brackets and large soft peg set. Replaces rear passenger floor guards.

VT No. 27-0578



Male End Mount Adjustable Footpeg Kit.

• Chrome with rubber rails and include an adjustable mount bracket.

• Fits FLT 1993-up

VT No. 27-0564



27-0517 Installed with 27-1586

27-0517



27-1796

Passenger Footpeg Mount Bracket Set.

• Fits FLT 1993-up

• Adjusts to 3 height positions.

• Replaces stock rear footboards.

• Order male pegs separately.

Chrome	Black	Item
27-0517	27-1796	Peg Mount
27-0440	27-0441	Mini Board
27-0831		Footboard Mount Kit



28-2120



28-2148

Stock Black Rubber Passenger Footboard

• Fits factory passenger floor boards.

• 1987-up FLT.

VT No.	Style
28-2120	Block, pair
28-2148	Ribbed, each



27-0964

27-0977

Streamliner Passenger Footboard Kit.

• Includes footboards, rubber pads, mounting hardware. Pads feature three chrome ribs. Set has bolt on installation. Replaces 50378-07B.

Chrome	Black	Item
27-0964	27-0977	Kit



Chrome Passenger Footboard Set

• Without rubber inserts. Accepts black passenger footboard mat black, OEM #50606-86A, and passenger footboard pin kit, OEM #50933-86.

VT No. 27-0016



Passenger Streamliner Style Footboard Set

• Includes rubber inserts. Order pins separately. Black finish. Fits 1993-up FLT.

VT No. 27-1762



27-1125



27-1126



27-1123



27-1124

Footboard Set

Chrome	Black	Item
27-1125	27-1126	Block Passenger Rear Footboard Kit
27-1123	27-1124	Ribbed Rear Passenger Kit
27-1549	27-1458	Streamline, FLT 1993-up
27-1456		Streamline, FLT 1993-up



27-1127



27-1128



27-1130

Mount Kit

Chrome	Black	Item
27-1127	27-1128	Reduced Reach Passenger Mount Kit
27-1129	27-1130	Adjustable Passenger Mount Kit



27-0164



27-0165

Passenger Footboard • Fits 1993-up FLT

VT No.	Item
27-0164	Digi Cut, Chrome
27-0165	Digi Cut, Black



27-0837

27-0837 Installed



27-0149



27-0148

Left Side Footboard Heel Guards

• Fit 1986-up FL style boards.

VT No.	Finish
27-0148	Chrome
27-0149	Black
27-0837	Chrome



27-1527

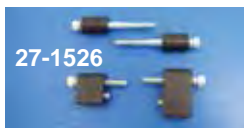

27-1526

Footboard Extender Kit

• Fits Touring. This kit is finished in black to extend footboards outward by 1¼" inches.

VT No.	Year
27-1527	1980-08
27-1526	2009-up



1" Footboard Extender

• Fits 1993-up FLT.

VT No. 27-1235



51-1601 Installed shown with 27-1235



27-0812



27-0811



27-1726



27-0811

Chrome Footboard Mount Set

• For FLT is a 4 piece set. Available in stock or +2" forward.

VT No.	Type	Finish	Year
27-1726	Stock	Chrome	1983-08
27-0811	+2"	Chrome	1983-08
27-0812	+2"	Black	1983-08
27-1793	Stock	Chrome	2009-up



27-0162



27-0163



27-0863

Half Moon Footboard Set

• Features OE style pads and Iso mounted pads.

VT No.	Finish
27-0162	Black
27-0163	Chrome
27-0863	Trim



Footboard Forward Relocation Kit

• Re-mount footboards 1" forward on 1997 and later Touring models.

VT No. 27-1539

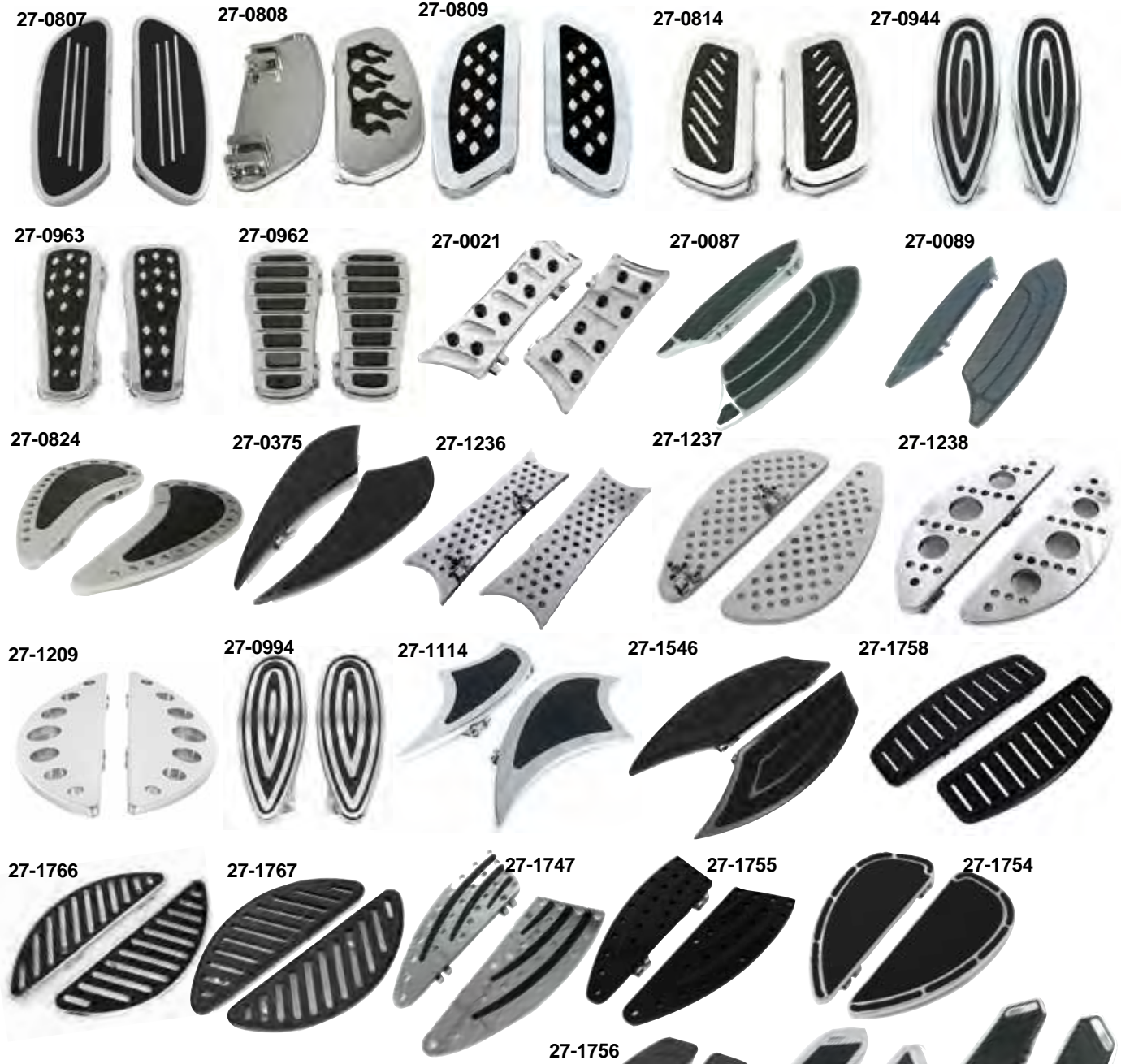

Streamliner Driver Footboard Sets

- Features rubber inlay for 1980-up FLT and 1986-up FLST.

Chrome	Black	Style
27-0807	—	Rail
27-0808	—	Flame
27-0809	—	Diamond
27-0814	—	Shark Fin
27-0944	—	Teardrop
27-0963	—	Diamond Big Foot
27-0962	—	Big Foot
27-0021	—	Slasher
27-0087	27-0089	Rocket
27-0824	—	Half Moon with rubber
—	27-0375	Shark Fin
27-1236	—	Swiss Cheese, Rectangular
27-1237	—	Swiss Cheese, Half Moon
27-1238	—	Drilled Half Moon
27-1744	—	Old School, Rectangular



27-1209	—	Half Moon Holes
27-0994	—	Oval Design
27-1114	—	Shark Fin with rubber
—	27-1546	Shark Fin with rubber
—	27-1758	Slotted Ball Milled
27-1766	27-1767	Half Moon Slotted
27-1747	27-1755	Slanted Shark Fin
—	27-1754	Oblong Teardrop
—	27-1756	Rectangular with raised rubber areas
27-0166	27-0167	Digi
27-0452		Bolt Set (Zinc)



Driver Footboard



27-1251



27-1251 Installed



27-1250



27-1250 Installed



27-1200



27-1201



27-1202



27-1202 Installed



27-0898



27-0898 Installed



27-0822



27-1752



27-1752 Installed

“D” Billet Footboard Set.

• Note: Fit 1980-up FLT and 1986-up FLST

VT No.	Shape
27-1251	Diamond
27-1250	Rail
27-0898	Flame
27-0787	Dreamer
27-0822	Wave

Billet Footboard Set.

• Note: Fit 1980-up FLT and 1986-up FLST

VT No.	Shape
27-1200	Diamond
27-1201	Rail
27-1202	Flame
27-1752	Oval



27-0914



27-0863

Vintage Footboard Sets

• Feature classic half moon design with “shaker” Iso-mount cushion area. Black pads included.

VT No.	Fits
27-0914	1980-up FLT
27-0863	Rail Trim



27-0855



Chrome Black Item
27-0855 Driver Set with Streamliner Design



27-0188



27-0748



Chrome Footboard Set

• Features ISO mounted rubber pads. Fits 2006-up FLT.

VT No.	27-1784
--------	---------

Wyatts Driver Footboards.

VT No.	Finish/Fits
27-0188	Black, 1986-up FLH, 1986-up FLST
27-0748	Black, 1980-up FLT, 1986-up FLST

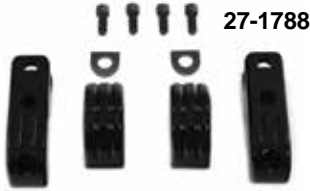

27-1788



27-0698



27-0032



27-0033



27-0660
Installed

27-0660



27-0034

Chrome Extended Footpeg Mount Kit

For custom application

VT No.	Mount Diameter
27-0032	1"
27-0033	1 1/8"
27-0034	1 1/4"



27-0654

27-0587



27-1452

27-1453



27-0892 Installed



27-0892



27-0665

Footpeg Mounts for 1 1/4" front engine bars. Order pegs separately.

VT No.	Type
27-1452	Long
27-1453	Short
27-0665	Angle
27-0753	Adjustable Kit



27-0651

Chrome 1 1/4" Engine Bar Footpeg Mount Kits

- For the mounting of male footpeg sets to 1 1/4" engine bars.
- Hardware included.

*Includes footpegs. All other items purchase footpegs separately.

For custom application	
VT No.	Item
27-1788	Grooved Black Mount Kit
27-0698	Grooved Chrome Mount Kit
27-0654	Grooved Chrome Mount Kit
27-0660*	Above w/Cats Paw pegs
27-0587*	Above w/Railer pegs
27-0892	Rounded Chrome Kit
27-0651	Basic Kit



31-0201

31-0264

31-0282

31-0983

31-0933

Inspection Tag Holder

- Available in stainless or chrome. Measuring 3 1/2" square with 1/2" or 3/8" mounting hole which can mount to footpeg or shock studs. 31-0282 is square type which clamps on to 1" to 1 1/8" tube with worm clamp included.

VT No.	Item	Type
31-0201	Stainless	.5"
31-0264	Chrome	.5
31-0933	Black	.5
31-0983	Chrome	3/8"
31-0282	Chrome	Clamp

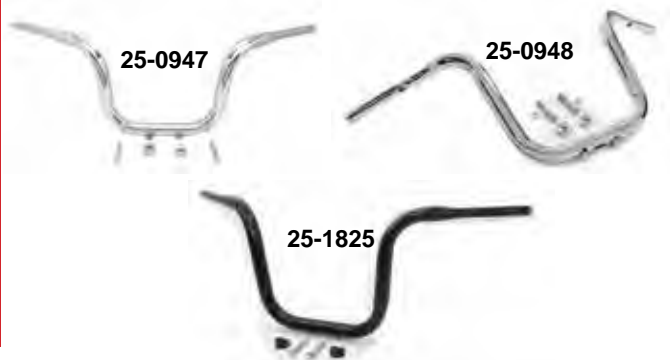

Adjustable Ape-Hanger Bars

• Feature a built in bolt which is in a track to allow fore and aft adjustment. Bars bolt directly to triple tree, no risers needed.

Chrome	Black	Height	Fits
25-0947	25-1825	12"	1980-83, 1984-13 FLT
25-0948	25-1826	14"	1980-83, 1984-13 FLT
25-0949	25-1827	15"	1980-83, 1984-13 FLT

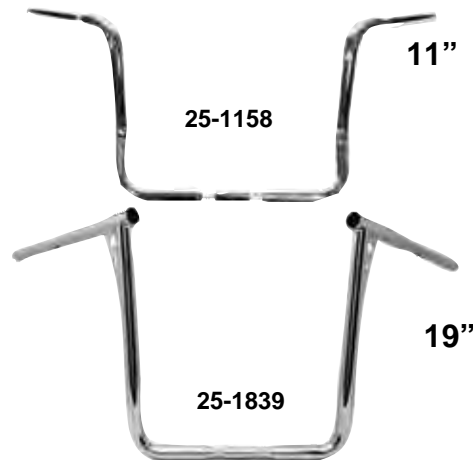

Dresser Ape Hangers

Chrome	Black	Height	Description	Fits
25-1158		11"	With TBW	2008-13
25-0995	25-0982	12"	Ape Style	2008-13
25-1129		14"	With Indents	1982-07
25-1131		19"	With Indents	1982-07
25-1159		14"	With TBW	2008-13
25-1838	25-1844	16"	With TBW	2008-13
25-1839	25-1845	19"	With TBW	2008-13
25-1161		19"	With TBW	2009-up



Bagger Z Bars

• Feature set back to accommodate fairing. **Note:** 2008-up style accept "throttle by wire" right side grip.

VT No.	Height	Description	Fits
25-2276	15"	with Indents & TBW	1982-13 FLT
25-0846	15"	with Indents	1982-07 FLT
25-3251	15"	with TBW	2008-13 FLT
25-1180	16"	with TBW	2008-13 FLT



Bagger Ape Style Bars

• Fit 2014-up, 1 1/4" round

Chrome	Black	Size
25-0446	25-0501	12"
25-0447	25-0502	13"
25-0448	25-0503	14"
25-0449	25-0504	16"
25-0450	25-0505	18"

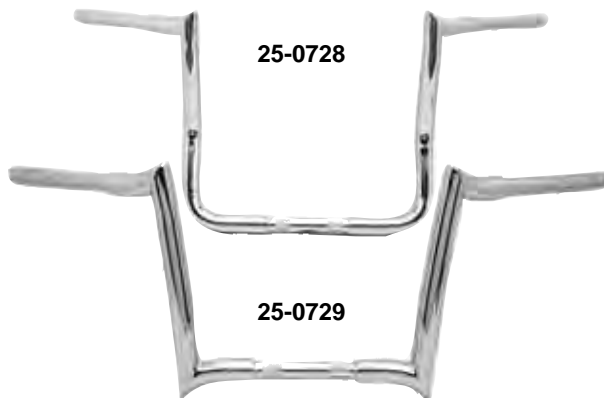

Chrome Monkey Bagger Bars

VT No.	Height	Fits
25-0728	15" without indent	2008-13 FLT
25-0729	12" without indent	2008-13 FLT



Poly Urethane Riser Bushing Set includes 4 bushings with chrome covers.

VT No.	Fits	Year
28-2259	FLT	1983-13

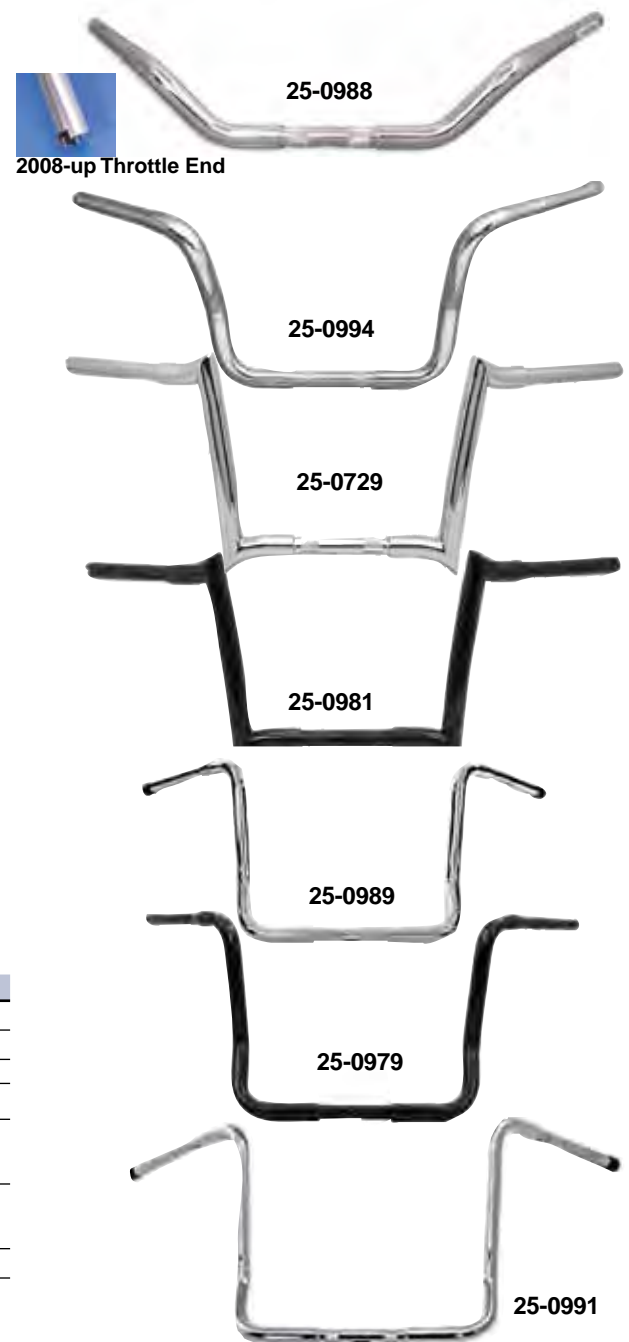

Replica Handlebars

Chrome	Size	Description	Fits
25-0875	6"	Replica Handlebars with Indents	1982-07 FLT
25-1840	8"	Glider Handlebar without Indents	1986-13 FLH
25-0665	8½"	Replica Handlebar with Indents	1982-07 FLT
25-0794	9"	Replica Handlebar with Indents	1982-07 FLT
25-1841	9"	Glider Handlebar without Indents	1986-13 FLHT
25-1835	9"	Vintage Handlebar without Indents	1986-13 FLHT
25-0876	10½"	Replica Handlebar with TBW	2008-13 FLT

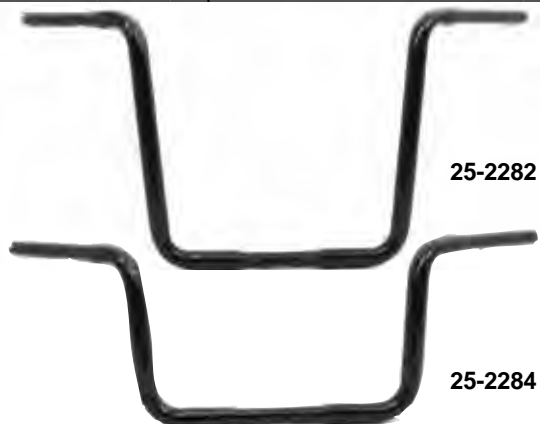

Black Bars. *Note: Throttle by wire

VT No.	Rise	Type
25-2282*	17"	Wide Body Ape Hanger
25-2283*	14"	Wide Body Ape Hanger
25-2284*	11"	Wide Body Ape Hanger

Round Bagger Bars.

• 1¼" bars fit FLT models and feature set back to accommodate fairing. Note: 2008-13 style accept "throttle by wire" right side grip

Chrome	Black	Description	Fits
25-0988		3½" Without Indents	2008-13
25-0993		3½" With Indents	1982-07
25-0994		12" With Indents	1980-07
25-0729	25-0981	12" Without Indents	2008-13
	25-0452	13" With Indents	1982-07
25-0728	25-0980	15" Without Indents	2008-13
25-0989	25-0979	15" With Wiring Holes	2008-13
25-0786		16" With Indents	1982-07
25-0991	25-0978	16" With Wiring Holes	2008-13

1982-up Hand Lever



Contour Levers

Chrome	Black	Year	Type
26-2178		1996-06	Smooth
26-0788	26-0984	1996-07	Drilled
26-0789	26-0111	1996-07	Slotted
26-0741	26-0981	2008-13	Smooth
26-0895	26-2113	2008-up	Slotted
26-0763	26-0762	2008-up	4 Hole
26-0765	26-0940	2014-up	Smooth
	26-0768	2014-up	Smooth
26-0767		2014-up	Trike Smooth

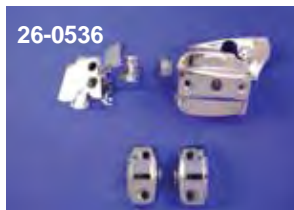

Chrome Handlebar Control Cover Set

• Includes clutch lever bracket, handlebar control clamps, master cylinder top and body cover, and hardware for complete installation.

VT No.	OEM	Disc	Year
26-0536	46098-98	Single	1996-2005
26-0537	46099-98	Dual	1996-2005



Clutch and Brake Levers

• Available in polished or chrome. Sold individually.

Chrome	Polish	OEM	Years	Type
26-0527	26-0528	45016-72	1972-81	Brake
	26-0517	Power	1972-81	Brake
	26-0519	Power	1972-81	Brake
26-0531	26-2136	45017-82	1982-95	Clutch
26-2133		45017-88	1988-95	Clutch
26-0532		45016-82	1982-95	Brake
	26-2135	45016-82	1982-95	Brake



Mirror Mount Block

• Fits 1996-2007 handlebar master cylinder to allow use of custom mirrors with larger than stock stem by moving the mirror stem up and out from the master cylinder.

VT No.	Item
31-0519	Right
34-9158	Right and Left
34-1968	As Above, black

Hand Lever Set.

• Fits 2014-up FLT

Chrome	Black	Style
26-0798	26-0799	Vortex Lever Set
26-0800	26-0801	Drilled Lever Set



Chrome Master Cylinder Assembly Kits

• Include switch housings. Kits fit 1996-06 with 1", 1¼" or 1½" handlebars. Available with or without chrome switches.

VT No.	Bore
22-0813	9/16"
22-0814	1 1/16"



Models & Description	Bore	Without wiring
96-07 FLT Dual Disc with radio	1 1/16"	22-0883
96-07 FLT Dual Disc w/radio & cruise	1 1/16"	22-0881
08-up FLT Dual Disc with radio	15mm	22-0880
08-up FLT Dual Disc with radio & cruise	15mm	22-0882



26-0402

Chopped Handlebar Master Cylinder and Control Housing Set

- For 1996-10 models.
- Fits 1996-up FLT without cruise radio controls

With Switches	Without Switches	Years	Disc	Size
26-0410	26-0402	1996-05	Single	9/16"
26-0411	26-0405	1995-04	Dual	1 1/16"
—	26-0406	1996-2004 FLT/FLHT	Dual	1 1/16" w/Radio
—	26-0407	1996-2004 FLHT	Dual	1 1/16" w/Radio
—	26-0455	2014-up	Dual	Black



1996-07 Chrome Control Dress Up Kit

includes clutch lever bracket, handlebar control clamps, master cylinder top and body cover with levers and hardware for disc models as noted.

VT No.	Year	Model	Type
26-0549	1996-07	FLHT/TCU	Dual Disc
2553-10	2008-up	Screw Kit	



Chrome Smooth-Contour Control Kit

- Features a hidden underside mounting on the switch housings for an unobstructed smooth, rounded surface on the top housing.
- Switch housings use stock or chrome 1996-06 switches. Available in complete kits with or without chrome switches. Complete kits include clutch and brake levers, master cylinder, switch housings, brackets and hardware.

Without Switches	With Switches	Type	Disc
	22-0817	(.562) 9/16" MC	Single
22-0821	22-0818	(.687) 1 1/16" MC	Dual



Chrome Handlebar Control Cover Kits

- Include master cylinder cover, clutch mount and two clamps.

VT No.	Model	Disc
26-0747	2008-up FLT without hyd clutch	Dual
26-0181	2005-07 FLT	Dual



Chrome Handlebar Control Cover Kit

- Includes master cylinder

VT No.	Fits	OEM
26-0455	2014-up FLT	41700263



28-0298



28-0857



28-0647



28-0891



28-0988



28-0856



28-0846



28-0646



28-0645



28-0654



28-0640



28-0664

Handlebar Grip Sets

- For Touring models 2008-up
- Feature the built in serrations in the throttle side to twist the "TBW" throttle by wire electronic throttle assembly.

VT No.	Style
28-0298	Banded
28-0857	Flame
28-0647	Diamond
28-0891	Chrome Dome, 2008-up
28-0988	Swiss Cheese, Billet
28-0856	Vintage
28-0846	Stock Replica
28-0646	Iso Bar
28-0645	V-Tech
28-0654	Eagle Passion
28-0640	Tornado
28-0664	Slasher
35-9871	Tube

Handlebar Grip Sets.

2008-up Touring with TBW

28-0241	Plain, Chrome
28-0242	Shot Peened, Chrome
28-0243	Black with cut
28-0244	Stealth Tone Black

Black Cobra Grip.

VT No. 28-0926



28-0934



28-0935



28-0935 Installed



28-0935 Installed

Donkey Handlebar Grip Set with chrome end caps.

VT No. Type
 28-0934 Dual Cable
 28-0935 TBW

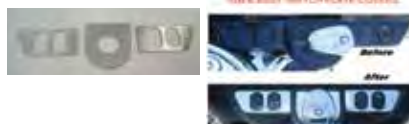

Ignition Switch Cover Set

- Fits 1996-2009 FLHT-FLHTCU and FLHX Touring models.
- VT No. 42-0166



32-1259

Chrome Switch Housing & Switch Assembly

- Includes 50" long leader wires and internal mount screws for Touring with radio and cruise control.

VT No.	Year
32-1259	1996-06



12V Receptacle

- For cell phone, MP3 player or lighter.

VT No. 32-0845



32-0276



32-0277



Handlebar Control Switch Housing Kits

VT No.	Item
32-0276	Chrome with chrome
32-0277	Chrome with black switches
32-0278	Black with black switches
32-0279	Black with chrome switches



2008-up Chrome Clutch Handle Assembly

- Includes mount bracket , clamp and handle assembled.

VT No. 26-2207



33-0561



33-0562

Universal Cigarette Lighter

- Available for panel mounting

VT No.	Type
33-0561	Without bracket
33-0562	With bracket



Traffic Light Sensor

- Triggers stoplight from motorcycle when on traffic light pad.

VT No. 32-1352



Chrome Electronic Device Holder

- Mounts to left side control clamp on 1996-up models.

VT No. 31-1233



26-0765



26-0452



26-0455



22-0583

Handlebar Control

Chrome	Black	Fits
26-0765	26-0768	Hand Lever for 2014-up, Chrome
26-0452	—	Switch Housing for 2014-up FLT
26-0455	—	Clutch Bracket & Master Cylinder Reservoir Kit
22-0583	—	Kit, 2014-up



48-0550

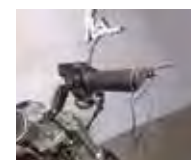

48-0449



48-1592

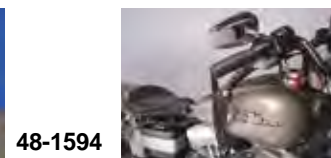

48-1594

Black Leather Accessories.

VT No.	Description
48-0550	Lever Covers
48-0449	Grip Covers
48-1592	Grip Covers with 10" fringe
48-1582	Lever Cover with 10" fringe
48-1714	Lever Covers with 16" fringe
48-1594	As Above 1993-up with 10" fringe



32-1525

32-1526



32-1534

32-1528



32-1529



32-6660



32-6661



32-6662



32-6663



32-6652



32-6653



32-6654



32-6655



32-6680

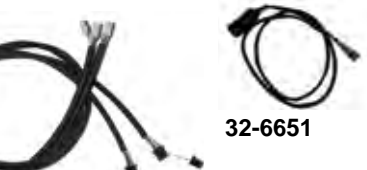

32-6686

32-6651

Chrome Handlebar Switch Kit.

VT No.	Years	Type
32-1525	2007-up	Radio
32-1526	2007-up	Radio/Cruise
32-1534	2007-up	As Above with black switches
32-1528	1996-06	Radio/Cruise
32-1529	1996-06	Radio



32-7015



32-7017



32-7016



32-7018

Backlit LED Handlebar Switches & Wiring Harness

• Without switch housing. LED is amber & wires 60" in length.

Black	Chrome	Fits
32-7014	32-7019	1998-up FLHTCUI
32-7015	32-7020	2008-up FLHX
32-7016	32-7021	2006-2007 FLHX
32-7017	32-7022	1998-2003 FLHTC
32-7018		2004-up FLHTC

Extended Handlebar Wiring Harness Kit

VT No.	Fits
32-7814	1996-06 FLT
32-7823	1996-2006 FLT with factory radio
32-7832	2009-2012 FLT with electric throttle

Handlebar Wiring Extension Kits.

Fits 1996-06 FLT, FLHT (12 Wires per side)

32-6660	+4" Extension
32-6661	+8" Extension
32-6662	+12" Extension
32-6663	+15" Extension
Fits 2007-13 FLHT, FLHR, FLHX, FLTR	
(12 Wires right/14 left)	

32-6652	+4" Extension
32-6653	+8" Extension
32-6654	+12" Extension
32-6655	+15" Extension
Fits 2007-13 FLHT, FLHR, FLHX, FLT (17 Wires, Note: Does not include wires for radio, CB or throttle controls).	

32-6680	+4" Extension
32-6682	+8" Extension
32-6683	+12" Extension
Fits 2014-up FLHT, FLHR, FLHX	
32-6686	+18" Extension
Fits 2008-up FLHT, FLHT, FLHX	
32-6651*	One Size

*Note: 18" Extended Throttle by Wire Harness Only

Throttle by Wire Handlebar Wiring Extension Kits includes factory type connectors for easy assembly.

32-6687	FLT 2014-2015
32-6688	+8" 2016-up FLT, FXST, FLST
32-6689	+15" 2016-up FLT, FXST, FLST

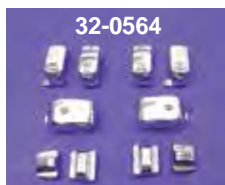

32-0564



32-0581



32-0563



32-0562



32-0565

Chrome Switch Cover Set.

Snap on covers replace existing black switch covers.

VT. No.	Fits
32-0564	1996-up FLHTCU (Ultra Classic Electra Glide) 1996-up FLTR (Road Glide)
32-0563	1996-up FLHT (Electra Glide Standard); 1996-up FLHTC (Electra Glide Classic) without cruise control
32-0562	1996-up FLHR (Road King), 1998-01 FLHRCI (Road King Classic)
32-0565	2002-up FLHRCI (Road King Classic) with cruise control
32-0581	1996-up FLHT with cruise control, FLHTC, 2006-up FLHX without cruise control



32-0364



32-0365



32-0367



32-0366



32-0368

Chrome Rocker Style Handlebar Switch Kit

VT No.	Item
32-0364	Rocker Switch Kit Chrome Set of 2. Cruise/Accessory with Harness & Connector 2008-up FLHX OEM 70219-08CP
32-0365	Rocker Switch Kit Chrome Set of 4. Cruise/Accessory/Spot Lamp/Speaker with Harness and Connector. 1998-up FLHTCUI OEM 70271-98CP
32-0366	Rocker Switch Kit Chrome set of 3. Cruise/Accessory/Spot Lamp 2004-up FLHT/C OEM 70278-04CP
32-0367	Rocker Switch Kit Chrome Set of 2. Cruise/Accessory with Harness and Connector. 2004-up FLTR OEM 71625-04CP
32-0368	Rocker Switch Kit Chrome Set of 2. Speaker with Harness and Connector. 1998-03 FLTR OEM 71655-98CP



26-2253

26-2254

26-2256

Chrome Switch Housing Kit

Includes press on chrome switch caps for easy installation.

VT No.	Model
26-2253	1996-2013 FX-XL-FXD-FLHR without cruise control
26-2254	1996-2013 FLHT/C/I
26-2255	FLHTCUI, FLTRI, 1996-up
26-2256	FLHRCI 2002-up



32-1129



32-1130



32-1131



32-1132



32-1133



32-1134

LED Rocker Switch Kits

VT No.	Fits	Function
32-1129	2007-up FLT	Radio
32-1130	1996-06 FLT	Radio
32-1131	2007-up FLT	Cruise
32-1132	1996-06 FLT	Cruise
32-1133	2007-up FLT	Radio/Cruise
32-1134	1996-06 FLT	Radio/Cruise



32-1091



32-1092



32-1093



32-1094



32-1095

Gold Switch Cover Kits.

VT No.	Fits
32-1091	FXD, FXST, FLHR 1996-up, VRSC 2002-2002, FLHRCI 1998-2001
32-1092	FLHT 1996-up without cruise control
32-1093	FLHTCUI, FLTR 1996-up
32-1094	FLHRCI 2002-up without cruise control
32-1095	FLHT, FLHTC 1996-up, FLHX 2006-up use on cruise control models



33-0922



Complete Horn Kit

• Includes 12 volt compressor, 150mm and 195mm chrome horn set, bracket and cover. **VT No. 33-0922**



33-1006

Air Horn Kit

• Includes dual chrome horns with black end caps, 12 volt compressor, cover, and chrome mount bracket.

VT No. 33-1006



33-1909

42-5043

Chrome Air Horn Kit

• Includes 12V compressor. 150 mm and 195 mm horns.

VT No.	Item
33-1909	Horn Kit
42-5043	Cover
31-1178	Bracket



Chrome Air Scoop

• Mounts on left side top motor mount studs on 1991-up Touring models. Will act as scoop for improved cooling and horn cover.

VT No. 42-1010

42-1134



42-5041



42-1135



42-1053



42-1179



42-1084



42-5047



42-1182



42-1194



Horn Covers

• Round and CVO style horn covers with finishes as noted
• Fits 1993-up FLT except where noted..

VT No.	Style
42-1134	Round Spoke Chrome
42-5041	Skull
42-1135	Round Slotted Chrome 1991-up
42-1053	Chrome CVO
42-1179	Black CVO
42-1084	Louvered Chrome
42-5047	Black Skull 1991-up
42-1182	Smooth Round, Black 1991-up
42-1194	Black Wrinkle 1991-up



34-8218 Installed

Chrome Mirror Set

- Offers updated styling as mirrors mount behind fairing at grip area. Drilling of fairing shell required.

VT No. 34-8218



Fairing Mount Mirror Kit

- Fits FLT models.
- Mount inside the "bat wing" style fairing and feature a wide range of adjustments.
- Mounting template for easy installation

1996-13	2014	Item
34-0405	34-0055	Chrome Kit
34-1335	34-0056	Black Kit
34-1336	34-0058	Black Kit, Split Vision
34-1337	34-0057	Chrome Kit, Split Vision



Mini Fairing Mount Mirror.

Chrome	Black
34-1736	34-1737



Touring Mirror Set

- Available with optional LED turn signal set built in.

VT No.	Finish	Type
34-1221	Black	LED
34-1222	Chrome	LED
34-1224	Chrome	
34-1591	Cover Set	



Mirror Block Off Plates.

VT No.	Finish
34-0049	Mirror Block Plate, Chrome
34-0052	Mirror Block Plate, Black



Roller Dolly

- Holds up to 1250lbs
- VT No. 16-1026



Roller Dolly

- Features nylon wheel and has a capacity of 1250 lbs
- VT No. 16-1999



Factory Spare Parts Book

VT No.	OEM	Fits
48-0602	99456-01	2001 FLT
48-0718	99456-03	2003 FLT
48-1308	99456-11	2011 FLT



16-0529

Mini-Lift

- For use lift on table or floor to free wheels. 1000 lbs capacity with a rubberized top plate. V-Twin logo and bright orange paint.

VT No. 16-0529

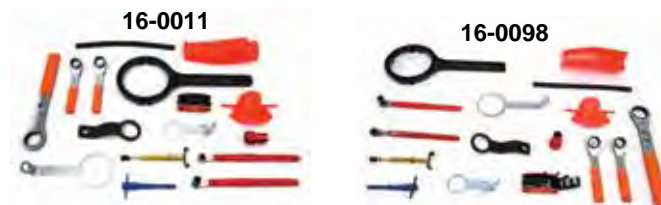

DIY Touring Tool Kit

- For 1999-2013 models will fit in a kidney shaped tool box. Includes rider tools and service tools for the rider-mechanic.

VT No.	Fits
16-0011	1999-13
16-0098	2014-up



Ignition Switch Tools

VT No.	Fits
16-0003	2003-13
16-0017	2003-13
16-1137	2014-up
16-1265	2014-up



Tool Kits

VT No.	Fits
16-0857	1985-up
16-0850	1979-84

