



RIOT SHIFT PEGS & FOOTPEGS PG 100



EXTENDED BRAKE PEDALS PG 137



HEAVY INDUSTRY FLOORBOARDS
& BRAKE PEDALS PG 98

FOOT CONTROLS

FOR HARLEY-DAVIDSON®

FOOTPEGS, SHIFT PEGS, BRAKE PEDAL PADS & FLOORBOARDS	98
FOOTPEG & FLOORBOARD ADAPTERS	117
FOOTPEG & FLOORBOARD RELOCATORS	118
PASSENGER PEGS: FIXED & ADJUSTABLE	121
ENGINE GUARDS	127
HIGHWAY & CRUISE PEGS	128
CLAMPS & MOUNTS	132
SHIFT LINKAGES, ARM COVERS & SHIFT LEVERS	133
BRAKE LEVERS	137
FORWARD CONTROLS	138

PEGS & FOOT CONTROLS FOOTPEGS, SHIFT PEGS & BRAKE PEDAL PADS

Style Guide

KURYAKYN OFFERS MULTIPLE COLLECTIONS OF FOOT CONTROLS WITH A VARIETY OF STYLES THAT COMBINE FORM AND FUNCTION TO MEET THE WANTS AND NEEDS OF ANY RIDER. ALL OF OUR FOOTRESTS ARE MODULAR AND UTILIZE EITHER A TAPERED (▲) OR SPLINED (◆) ADAPTER THAT FITS YOUR SPECIFIC APPLICATION. REQUIRED ADAPTER IS LISTED BY EACH PEG, BOARD, OR MINI BOARD ON PAGES 98-116. (SOLD SEPARATELY)



FOOTPEGS, SHIFT PEGS & BRAKE PEDAL PADS PEGS & FOOT CONTROLS

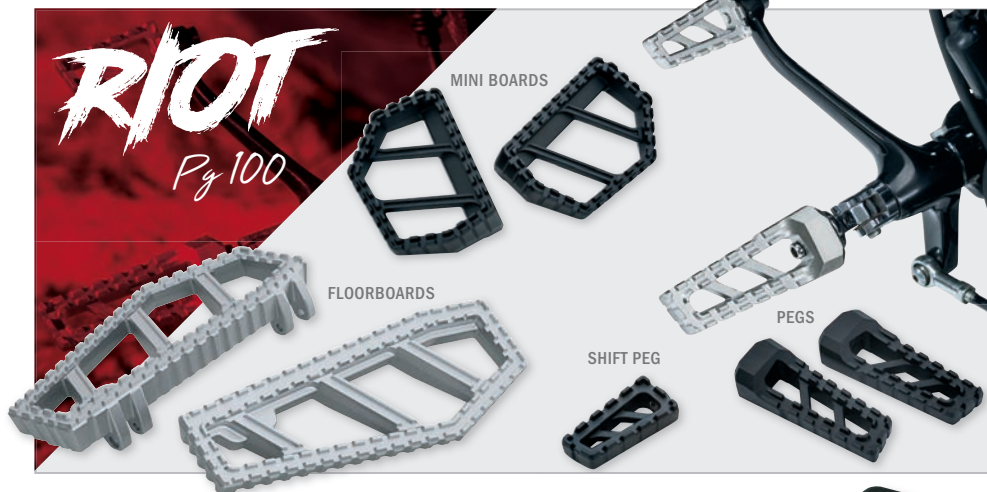

FOR HARLEY-DAVIDSON®

NEW

FEATURED BIKES

COLLECTIONS

Audio

Lighting

Accessory Mounts

Handlebar Controls, Grips & Mirrors

Pegs & Foot Controls

Covers, Trims & Accents

Air Cleaners

Crusher

Exhaust

Air Cleaners

Performance Components

Touring & Comfort

Windshields & Air Management

Luggage Organizers & Storage Covers

INDEX



PEGS & FOOT CONTROLS FOOTPEGS, SHIFT PEGS & BRAKE PEDAL PADS



HEAVY INDUSTRY PEGS

Sized to offer ideal surface area for confident control, with splined adapters that allow the footpeg angle to be dialed in for optimum comfort. Premium rubber reduces harsh road vibrations and surrounds a knurled aluminum center for overall improved traction.

MULTI-FIT

Fits: See Fitment Chart Below

WITH MALE MOUNT ADAPTERS

7031	Chrome (pr)	\$89.99
7032	Satin Black (pr)	\$89.99

WITHOUT ADAPTERS *

7033	Chrome (pr)	\$79.99
7034	Satin Black (pr)	\$79.99



HEAVY INDUSTRY SWITCHBLADES

Tough, stylish and versatile with flip-out heel rests for additional foot support and unrivaled long-haul comfort. Cast from quality A380 aluminum with a rugged design featuring a knurled top surface area surrounded by premium rubber for reduced vibration, solid traction and confident control.

MULTI-FIT

Fits: See Fitment Chart Below

WITH MALE MOUNT ADAPTERS

7027	Chrome (pr)	\$139.99
7028	Satin Black (pr)	\$139.99

WITHOUT ADAPTERS *

7029	Chrome (pr)	\$129.99
7030	Satin Black (pr)	\$129.99



HEAVY INDUSTRY SHIFT PEG

A direct replacement for stock H-D shift pegs with rugged style and durable construction. Premium rubber frames the outer perimeter for reduced vibration and improved control, while the knurled aluminum center provides traction for your boots.

FOR HARLEY-DAVIDSON®

Fits: All H-D Shift Levers

7035	Chrome (ea)	\$29.99
7036	Satin Black (ea)	\$29.99



FITMENT CHART

WITH MALE MOUNT ADAPTERS

FOR HARLEY-DAVIDSON®

Fits: Universal Fitment for All Kuryakyn Male Mount Footpeg Clevises, Direct Replacement for H-D Style Male Mount Footpeg Applications (except '11-'17 XL1200C Sportster Custom, '12-'16 XL1200V Sportster Seventy-Two & '10-'17 XL1200X Sportster Forty-Eight)

WITHOUT MALE MOUNT ADAPTERS

FOR HARLEY-DAVIDSON®

Fits: OEM Stock Foot Peg Mount Location, Requires Model Specific Tapered (▲) or Splined (✱) Adapters (Sold Separately) Found On Page 117

FOOTPEGS, SHIFT PEGS & BRAKE PEDAL PADS PEGS & FOOT CONTROLS

FOR HARLEY-DAVIDSON®

HEAVY INDUSTRY

HEAVY INDUSTRY BRAKE PEDAL PADS

Heavy Industry Brake Pedal Pads are the epitome of durability, style and function. A premium rubber insert exposes socket head fasteners as it wraps around the knurled aluminum center for improved traction and a rugged, contrasting appearance.

FOR HARLEY-DAVIDSON®

Fits: '80-'17 Electra Glides, Road Glides, Road Kings, Street Glides, Tour Glides & Trikes; '86-'17 FL Softail Models & '12-'16 Dyna Switchbacks

7039	Chrome (ea)	\$44.99
7040	Satin Black (ea)	\$44.99

Fits: All '84-'17 FX Softail Models, '08-'11 FXCW/C Rocker Models, '93-'17 FXDWG Dyna Wide Glide Models, '08-'17 FXDF, Dyna Fat Bob Models with Forward Controls, '15-'17 XG Street Models & All Kuryakyn Forward Controls

7037	Chrome (ea)	\$39.99
7038	Satin Black (ea)	\$39.99

HEAVY INDUSTRY FLOORBOARDS

FOR DRIVER AND PASSENGER

These cast aluminum boards feature a rugged, industrial design with vibration-dampening soft rubber inserts for comfort and traction.

FOR HARLEY-DAVIDSON®

FOR DRIVER

Fits: '83-'17 Electra Glides, Road Glides, Road Kings, Street Glides, Tour Glides, Trikes, '86-'17 FL Softail Models & '12-'16 Dyna Switchback

7041	Chrome (pr)	\$249.99
7042	Satin Black (pr)	\$249.99

FOR PASSENGER

Fits: '93-'17 Electra Glides, '98-'09 Road Glides (except '00-'01 & '09 FLTRSE), '11-'13 & '17 FLTRU Road Glide Ultras, '94-'17 Road Kings (except, '04-'07 FLHRS; '02-'03, '07-'08 & '13-'14 FLHRSE), '93-'96 Tour Glides, '09-'17 Trikes and '86-'17 Softail & '06-'17 Dyna Models with H-D Accessory Passenger Floorboard Kits

7043	Chrome (pr)	\$199.99
7044	Satin Black (pr)	\$199.99



COMPLETE THE LOOK HEAVY INDUSTRY GRIPS PG 77



NEW

FEATURED BIKES

COLLECTIONS

Audio

Lighting

Accessory Mounts

Handlebar Controls, Grips & Mirrors

Pegs & Foot Controls

Covers, Trims & Accents

Air Cleaners

Crusher

Exhaust

Air Cleaners

Performance Components

Touring & Comfort

Windshields & Air Management

Luggage Organizers & Storage Covers

INDEX



PEGS & FOOT CONTROLS FOOTPEGS, SHIFT PEGS & BRAKE PEDAL PADS**RIOT FOOTPEGS** 🌟

Authentic and industrial MX-styled pegs suited for aggressive riders who like to throw down on any terrain. Rugged cast aluminum construction featuring a serrated toothed top surface for no-slip traction to rip up the streets, tracks or trails. Footpegs measure 4.6" long x 1.64" wide x 1.29" thick (inner thickness, .66" outer thickness) and accept model-specific splined adapters (sold separately) for ideal angle adjustment.

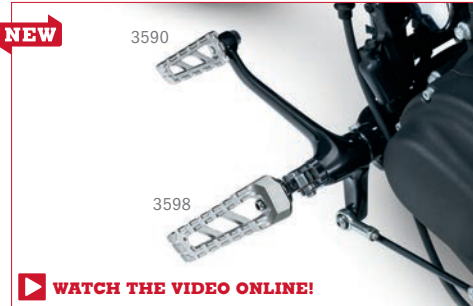

▶ WATCH THE VIDEO ONLINE!

**MULTI-FIT**

Fits: See Fitment Chart Below

3598	Silver (pr)	\$69.99
3599	Satin Black (pr)	\$69.99

RIOT SHIFT PEGS

Dirt track-styled direct replacement for H-D-style shift pegs, measuring 2 1/2" long x 1 1/4" wide. Rugged cast aluminum construction with smooth bottom to prevent boot scuffing and serrated toothed top surface for no-slip traction to rip up the streets, tracks or trails.

FOR HARLEY-DAVIDSON®

Fits: All H-D Shift Levers

3590	Silver (ea)	\$29.99
3591	Satin Black (ea)	\$29.99

FITMENT CHART**WITH MALE MOUNT ADAPTERS****FOR HARLEY-DAVIDSON®**

Fits: Universal Fitment for All Kuryakyn Male Mount Footpeg Clevises, Direct Replacement for H-D Style Male Mount Footpeg Applications (except '11-'17 XL1200C Sportster Custom, '12-'16 XL1200V Sportster Seventy-Two & '10-'17 XL1200X Sportster Forty-Eight)

WITHOUT MALE MOUNT ADAPTERS**FOR HARLEY-DAVIDSON®**

Fits: OEM Stock Foot Peg Mount Location, Requires Model Specific Tapered (▲) or Splined (🌟) Adapters (Sold Separately) Found On Page 117

FOOTPEGS, SHIFT PEGS & BRAKE PEDAL PADS PEGS & FOOT CONTROLS

RIOT MINI BOARDS

Ideal for hardcore riders seeking an aggressive look combined with the comfort of enhanced foot room. Accepts splined adapters to allow forward, back or center positioning at almost any angle. Tough MX styling with durable cast aluminum construction featuring a serrated toothed top surface for no-slip traction to rip up the streets, tracks or trails. Boards measure 5-1/2" long x 3-3/4" wide x 1-1/2" thick (inner thickness, 1/2" outer thickness).

MULTI-FIT

Fits: See Fitment Chart Left

3596	Silver (pr)	\$79.99
3597	Satin Black (pr)	\$79.99

Note: Does not fit the rider position for XG Street models.



RIOT FLOORBOARDS

Rugged MX-styled direct replacements for stock H-D floorboards featuring a tapered design from front to back for aggressive cornering clearance and ample foot room. Sturdy cast aluminum construction with serrated toothed top surface for no-slip traction and control to rip up the streets. Floorboards measure 11-3/4" long x 5" wide (at widest point) x 1-1/4" tall (inner height, 1" outer height).

FOR HARLEY-DAVIDSON®

Fits: '83-'17 Electra Glides, Road Glides, Road Kings, Street Glides, Tour Glides; '09-'17 Trikes, '86-'17 FL Softail Models & '12-'16 Dyna Switchbacks

3594	Silver (pr)	\$159.99
3595	Satin Black (pr)	\$159.99



SPEAR FOOTPEGS

A flattened top surface provides ideal foot placement and support, while premium EPDM rubber offers reduced vibration for comfort on long rides. Sharp styling complements the entire Spear collection.

MULTI-FIT

Fits: See Fitment Chart Left

5658	Chrome (pr)	\$89.99
5657	Satin Black (pr)	\$89.99



SPEAR MINI BOARDS

Model-specific Splined Adapters position the boards forward, back or center at almost any angle, and proprietary EPDM premium rubber compound provides reduced vibration for long-haul comfort.

MULTI-FIT

Fits: See Fitment Chart Left

5652	Chrome (pr)	\$99.99
5653	Satin Black (pr)	\$99.99

FOR HARLEY-DAVIDSON®

NEW

FEATURED BIKES

COLLECTIONS

Audio

Lighting

Accessory Mounts

Handlebar Controls, Grips & Mirrors

Pegs & Foot Controls

Covers, Trims & Accents

Air Cleaners

Crusher

Exhaust

Air Cleaners

Performance Components

Touring & Comfort

Windshields & Air Management

Luggage Organizers & Storage Covers

INDEX



PEGS & FOOT CONTROLS FOOTPEGS, SHIFT PEGS & BRAKE PEDAL PADS**KINETIC™ FOOTPEGS**

U.S. Patent D723,981

Designed to keep you moving in comfort with the perfect blend of vibration-dampening EPDM rubber and style. Available in contrasting chrome or black finishes, complete the look with our Kinetic Grips for all-around comfort and style.

MULTI-FIT

Fits: See Fitment Chart Below

WITH MALE MOUNT ADAPTERS

4316 Chrome (pr) \$89.99

4317 Gloss Black (pr) \$89.99

WITHOUT MALE MOUNT ADAPTERS 🌸

4320 Chrome (pr) \$79.99

4321 Gloss Black (pr) \$79.99

**KINETIC™ SHIFT PEGS**

U.S. Patent D718,191

Kuryakyn's Kinetic Shift Pegs feature a modern design and help you power through the gears in comfort with the perfect blend of vibration-dampening EPDM rubber and style. Coordinate with our Kinetic Footpegs and Grips to complete the look. Available in Chrome or Gloss Black finishes.

FOR HARLEY-DAVIDSON®

Fits: All H-D Shift Levers

4304 Chrome (ea) \$24.99

4305 Gloss Black (ea) \$24.99

**KINETIC™ BRAKE PEDAL PAD**

U.S. Patent D718,192

Kuryakyn's Kinetic Brake Pedal Pads are made from quality cast aluminum and feature modern styling with vibration-isolating EPDM rubber to aid rider comfort. Available in chrome or gloss black finishes, complete the look with our Kinetic™ Shift Pegs, Footpegs, Floorboard Inserts and Grips.

FOR HARLEY-DAVIDSON®

Fits: '80-'17 Electra Glides, Road Glides, Road Kings, Street Glides, Tour Glides & Trikes; '86-'17 FL Softail Models & '12-'16 Dyna Switchbacks



4310 Chrome (ea) \$39.99

4311 Gloss Black (ea) \$39.99

FITMENT CHART**WITH MALE MOUNT ADAPTERS****FOR HARLEY-DAVIDSON®**

Fits: Universal Fitment for All Kuryakyn Male Mount Footpeg Clevises, Direct Replacement for H-D Style Male Mount Footpeg Applications (except '11-'17 XL1200C Sportster Custom, '12-'16 XL1200V Sportster Seventy-Two & '10-'17 XL1200X Sportster Forty-Eight)

WITHOUT MALE MOUNT ADAPTERS**FOR HARLEY-DAVIDSON®**

Fits: OEM Stock Foot Peg Mount Location, Requires Model Specific Tapered (▲) or Splined (🌸) Adapters (Sold Separately) Found On Page 117

FOOTPEGS, SHIFT PEGS & BRAKE PEDAL PADS PEGS & FOOT CONTROLS

KINETIC™ MINI BOARDS

Great for driver or passenger! 5" long x 4" wide. Mount via splined adapters so the board can be positioned forward, back, or center at almost any angle. Also a great option for Driver Cruise Pegs!

MULTI-FIT

Fits: See Fitment Chart Left

WITH MALE MOUNT ADAPTERS

7610	Chrome (pr)	\$109.99
7612	Gloss Black (pr)	\$109.99

WITHOUT MALE MOUNT ADAPTERS

7611	Chrome (pr)	\$99.99
7613	Gloss Black (pr)	\$99.99



KINETIC™ FLOORBOARD INSERTS

FOR DRIVER & PASSENGER BOARDS

Keep your feet buzz-free! Kinetic Floorboard Inserts fit right in place of stock pads for an instant upgrade in style and comfort. Complete the look with our Kinetic Shift Pegs and Brake Pedal Pad. Available in either chrome or gloss black finish.

FOR HARLEY-DAVIDSON®

FOR PASSENGER BOARDS

Fits: '86-'17 Electra Glides, Road Glides, Road Kings, Tour Glides & Trikes with Traditional D-Shaped Passenger Boards; '86-'17 Softail or '06-'17 Dyna Models equipped with H-D Accessory Passenger Floorboard Kits Using Traditional D-Shaped Passenger Boards

4398	Chrome (pr)	\$99.99
4399	Gloss Black (pr)	\$99.99

FOR SWEEP WING BOARDS

Fits: '04-'05 FLHTCSE, '06-'13 FLHTCUSE, '14-'17 FLHTKSE, '09 FLTRSE, '10-'13 & '15-'17 FLTRX/S, '11 FLTRUSE, '12-'13 FLTRXSE, '06-'17 FLHX/I, '14-'17 FLHX/S, '10-'12 FLHXSE, '04-'07 FLHRS/I, '07-'08 & '13-'14 FLHRSE, '10-'12 FLSTSE, '14-'15 FLSTNSE or any H-D Model equipped with H-D Swept Wing Shape Boards.

4396	Chrome (pr)	\$149.99
4397	Gloss Black (pr)	\$149.99

FOR TRADITIONAL BOARDS

Fits: '84-'17 Electra Glides (except '04-'05 FLHTCSE, '06-'13 FLHTCUSE, '14-'17 FLHTKSE), '98-'09 Road Glides (except '09 FLTRSE), '11-'13 & '16-'17 Road Glide Ultras (except '11 & '15-'16 FLTRUSE), '94-'17 Road Kings (except '04-'07 FLHRS, '07-'08 & '13-'14 FLHRSE), '84-'96 Tour Glides, '09-'17 Trikes, '86-'08 FLST/FLSTC, '90-'17 FLSTF, '93-'96 FLSTN, '97-'03 FLSTS, '05-'07 FLSTSC & '12-'16 FLD Dyna Switchback

4394	Chrome (pr)	\$149.99
4395	Gloss Black (pr)	\$149.99

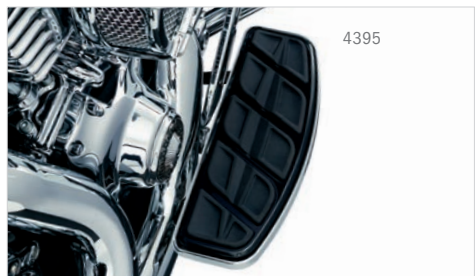

FOR HARLEY-DAVIDSON®

NEW

FEATURED BIKES

COLLECTIONS

Audio

Lighting

Accessory Mounts

Handlebar Controls, Grips & Mirrors

Pegs & Foot Controls

Covers, Trims & Accents

Air Cleaners

Crusher

Exhaust
Air Cleaners
Performance Components

Touring & Comfort

Windshields & Air Management

Luggage Organizers & Storage Covers

INDEX



PEGS & FOOT CONTROLS FOOTPEGS, SHIFT PEGS & BRAKE PEDAL PADS

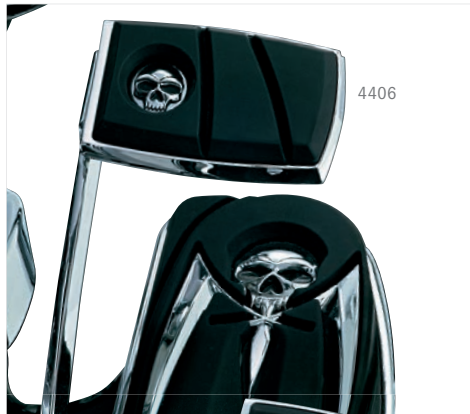
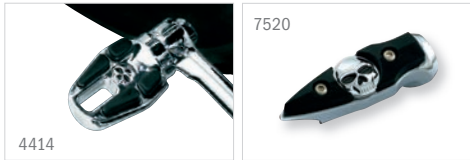
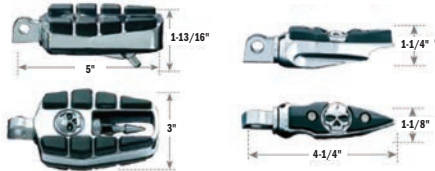

ZOMBIE™ PEGS

Unique style and durability make these pegs a stunning addition to your bike. All feature beautiful chrome with durable rubber pads and our ominous Zombie skull.

MULTI-FIT

Fits: See Fitment Chart Right

WITH MALE MOUNT ADAPTERS

4470	Zombie Pegs (pr)	\$119.99
7521	Mini Dagger Pegs (pr)	\$79.99

WITHOUT MALE MOUNT ADAPTERS

4471	Zombie Pegs (pr)	\$109.99
7520	Mini Dagger Pegs (pr)	\$69.99



ZOMBIE™ SHIFT PEG

4414

Beautiful chrome with durable rubber pads and our ominous Zombie skull. Wicked.

FOR HARLEY-DAVIDSON®

Fits: All H-D Shift Levers

4414	Zombie Shift Peg (ea)	\$29.99
------	-----------------------	---------

ZOMBIE™ BRAKE PEDAL PADS

All feature beautiful chrome with durable rubber pads and our ominous Zombie skull.

FOR HARLEY-DAVIDSON®

4406	Fits: '80-'17 Electra Glides, Road Glides, Road Kings, Street Glides, Tour Glides & Trikes; '86-'17 FL Softail Models & '12-'16 Dyna Switchbacks (ea)	\$39.99
4405	Fits: '84-'17 FX Softail Models (except '13-'14 FXSBSE), '08-'11 Rocker Models, '93-'17 Dyna Wide Glides, '08-'17 Dyna Fat Bobs with Forward Controls (except '09-'10 FXDFSE) & all Kuryakyn Forward Controls (ea)	\$39.99

REPLACEMENT RUBBER PADS & COMPONENTS

7512	Replacement Rubbers for Mini Dagger Pegs (set)	\$16.99
4474	Replacement Curb Feelers (set) Fits: Kuryakyn Widow & Zombie Pegs	\$16.99
4473	Replacement Skull Emblem (ea) Fits: Replacement for Kuryakyn P/N 4470 & 4471.	\$14.99
1492	Zombie Medallions, 1" Diameter (pr) Note: Replacement for Kuryakyn P/N's 1047, 1058, 1060, 7520, 7521, & 8606	\$18.99

FOOTPEGS, SHIFT PEGS & BRAKE PEDAL PADS PEGS & FOOT CONTROLS

ZOMBIE™ FLOORBOARD COVERS FOR DRIVER & PASSENGER

Created from a sculpted black rubber pad with a chromed inlay. Easily installed in place of the stock, ribbed rubber pads.

FOR HARLEY-DAVIDSON™

4566 Zombie Driver Floorboard Covers (pr) \$169.99
 Fits: '84-'17 Electra Glides (except '04-'05 FLHTCSE, '06-'13 FLHTCUSE, '14-'17 FLHTKSE), '98-'09 Road Glides (except '09 FLTRSE), '11-'13 & '16-'17 Road Glide Ultras (except '11 & '15-'16 FLTRUSE), '94-'17 Road Kings (except '04-'07 FLHRS, '07-'08 & '13-'14 FLHRSE), '84-'96 Tour Glides, '09-'17 Trikes, '86-'08 FLST/FLSTC, '90-'17 FLSTF, '93-'96 FLSTN, '97-'03 FLSTS, '05-'07 FLSTSC & '12-'16 FLD Dyna Switchback

4572 Zombie Inserts for H-D D-Shaped Passenger Boards (pr) \$79.99
 Fits: '86-17 Electra Glides, Road Glides, Road Kings, Tour Glides & Trikes with Traditional D-Shaped Passenger Boards; '86-'17 Softail or '06-'17 Dyna Models equipped with H-D Accessory Passenger Floorboard Kits Using Traditional D-Shaped Passenger Boards

WIDOW® PEGS

Distinct and durable, these pegs are built to stun. They look awesome by themselves or team them up with the rest of Kuryakyn's Widow series for an unparalleled look.

MULTI-FIT

Fits: See Fitment Chart Below

4491 Widow Pegs with Male Mount Adapter (pr) \$109.99
 4492 Widow Pegs without Male Mount Adapter (pr) 

WIDOW® SHIFT PEG

The perfect embellishment to our Widow Collection.

FOR HARLEY-DAVIDSON™

Fits: All H-D Shift Levers

4494 Widow Shift Peg (ea) \$26.99

WIDOW® BRAKE PEDAL PAD

Kuryakyn's Widow Brake Pedal Pads are as infectious as the rest of the series.

FOR HARLEY-DAVIDSON™

7533 Fits: '80-'17 Electra Glides, Road Glides, Road Kings, Street Glides, Tour Glides & Trikes; '86-'17 FL Softail Models & '12-'16 Dyna Switchbacks (ea) \$39.99

7534 Fits: All '84-'17 FX Softail Models, '08-'11 FXCW/C Rocker Models, '93-'17 FXDWG Dyna Wide Glide Models, '08-'17 FXDF Dyna Fat Bob Models with Forward Controls & All Kuryakyn Forward Controls (ea) \$39.99

4566

ZOMBIE

4566

WIDOW

4491

7533

7354

4494

FITMENT CHART

WITH MALE MOUNT ADAPTERS

FOR HARLEY-DAVIDSON™

Fits: Universal Fitment for All Kuryakyn Male Mount Footpeg Clevises, Direct Replacement for H-D Style Male Mount Footpeg Applications (except '11-'17 XL1200C Sportster Custom, '12-'16 XL1200V Sportster Seventy-Two & '10-'17 XL1200X Sportster Forty-Eight)

WITHOUT MALE MOUNT ADAPTERS

FOR HARLEY-DAVIDSON™

Fits: OEM Stock Foot Peg Mount Location, Requires Model Specific Tapered () or Splined () Adapters (Sold Separately) Found On Page 117

FOR HARLEY-DAVIDSON®

NEW

FEATURED BIKES

COLLECTIONS

Audio

Lighting

Accessory Mounts

Handlebar Controls, Grips & Mirrors

Pegs & Foot Controls

Covers, Trims & Accents

Air Cleaners

Crusher

Exhaust

Air Cleaners

Performance Components

Touring & Comfort

Windshields & Air Management

Luggage Organizers & Storage Covers

INDEX



PEGS & FOOT CONTROLS FOOTPEGS, SHIFT PEGS & BRAKE PEDAL PADS

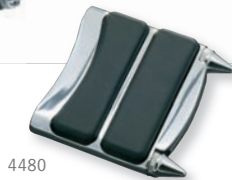
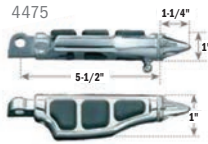

STILETTO™ PEGS

The radical Stiletto Peg is designed for those who ride on the wild side.

MULTI-FIT

Fits: See Fitment Chart Below

4475	Stiletto Pegs with Male Mount Adapter (pr)	\$109.99
4476	Stiletto Pegs without Male Mount Adapter (pr) ▲	\$99.99

STILETTO™ STIRRUPS

Relax and kick your heels up in style. Includes Stiletto Pegs and Stirrups.

FOR HARLEY-DAVIDSON®

Fits: See Fitment Chart Below

4477	Stiletto Pegs with Stirrups & Male Mount Adapters (pr)	\$179.99
------	--	----------

STILETTO™ SHIFT PEG

The radical Stiletto Peg is designed for those who ride on the wild side. The line includes pegs, pegs with stirrups and a brake pedal pad.



FOR HARLEY-DAVIDSON®

Fits: All H-D Shift Levers

4479	Stiletto Shift Peg (ea)	\$29.99
------	-------------------------	---------

STILETTO™ BRAKE PEDAL PAD

Designed to compliment the Stiletto line of footpegs, the Stiletto Brake Pedal Pad will carry the theme one step further.

FOR HARLEY-DAVIDSON®

Fits: All '07-'17 FX Softail Models, '93-17 FXDWG, '08-17 FXDF

4480	Stiletto Brake Pedal Pad (ea)	\$39.99
------	-------------------------------	---------

FITMENT CHART

WITH MALE MOUNT ADAPTERS

FOR HARLEY-DAVIDSON®

Fits: Universal Fitment for All Kuryakyn Male Mount Footpeg Clevises, Direct Replacement for H-D Style Male Mount Footpeg Applications (except '11-'17 XL1200C Sportster Custom, '12-'16 XL1200V Sportster Seventy-Two & '10-'17 XL1200X Sportster Forty-Eight)

WITHOUT MALE MOUNT ADAPTERS

FOR HARLEY-DAVIDSON®

Fits: OEM Stock Foot Peg Mount Location, Requires Model Specific Tapered (▲) or Splined (●) Adapters (Sold Separately) Found On Page 117

REPLACEMENT RUBBER PADS & COMPONENTS

4474	Replacement Curb Feelers (set) Fits: Kuryakyn Widow and Zombie Pegs	\$16.99
4483	Domed End Caps for Stiletto Stirrups (pr)	\$11.99
4488	Replacement Rubber Pads for Stiletto Brake Pad (set)	\$7.99
4489	Domed End Caps for Stiletto Brake Pedal Pad (pr)	\$11.99
4484	Domed End Caps for Stiletto Pegs (pr)	\$12.99
4485	Replacement Rubber Pads for Stiletto Pegs (set)	\$14.99
4487	Replacement Rubber Pads for Stiletto Shift Peg (set)	\$6.99
4490	Replacement Curb Feelers (pr)	\$10.99

FOOTPEGS, SHIFT PEGS & BRAKE PEDAL PADS PEGS & FOOT CONTROLS

FLAMIN' PEGS U.S. Patent D593,911

Flames add class and timeless design to your bike. Coordinate these pegs with our ISO-Flame Grips for a scorchin' hot look!

MULTI-FIT

Fits: See Fitment Chart Left

4416	Flamin' Pegs with Male Mount Adapter (pr)	\$109.99
4417	Flamin' Pegs without Male Mount Adapter (pr) 	\$99.99

4416



FLAME

FLAMIN' SWITCHBLADE PEGS

U.S. Patents D593,911 & 6,893,038

Tough, die cast zinc that's chrome plated with fastened rubber components that are not glued on. Switch it up and extend the heel stirrup for added comfort.

MULTI-FIT

Fits: See Fitment Chart Left

4411	Flamin' Switchblade Pegs with Male Mount Adapter (pr)	\$169.99
4412	Flamin' Switchblade Pegs without Male Mount Adapter (pr) 	\$159.99

4411



CLOSED

FLAMIN' SHIFT PEG

Features tough die-cast construction with a brilliant finish.

FOR HARLEY-DAVIDSON®

Fits: All H-D Shift Levers

4418	Flamin' Shift Peg (ea)	\$29.99
------	------------------------	---------

4418



4418

FLAMIN' BRAKE PEDAL PADS

Tough die-cast construction and brilliant chrome finish. Rubber components are physically retained, no more glued-on pads.

FOR HARLEY-DAVIDSON®

7518	Fits: '80-'17 Electra Glides, Road Glides, Road Kings, Street Glides, Tour Glides & Trikes; '86-'17 FL Softail Models & '12-'16 Dyna Switchbacks (ea)	\$39.99
------	---	---------

7518



7518

FLAME FLOORBOARD COVERS FOR DRIVER & PASSENGER

Created from a sculpted black rubber pad with a chromed inlay.

FOR HARLEY-DAVIDSON®

7522	Flame Driver Board Covers (pr) Fits: '84-'17 Electra Glides (except '04-'05 FLHTCSE, '06-'13 FLHTCUSE, '14-'17 FLHTKSE), '98-'09 Road Glides (except '09 FLTRSE), '11-'13 & '16-'17 Road Glide Ultras (except '11 & '15-'16 FLTRUSE), '94-'17 Road Kings (except '04-'07 FLHR8, '07-'08 & '13-'14 FLHRSE), '84-'96 Tour Glides, '09-'17 Trikes, '86-'08 FLST/FLSTC, '90-'17 FLSTF, '93-'96 FLSTN, '97-'03 FLSTS, '05-'07 FLSTSC & '12-'16 FLD Dyna Switchback	\$169.99
------	--	----------

7523	Flame Inserts for H-D D-Shaped Passenger Boards (pr) Fits: '86-'17 Electra Glides, Road Glides, Road Kings, Tour Glides & Trikes with Traditional D-Shaped Passenger Boards; '86-'17 Softail or '06-'17 Dyna Models equipped with H-D Accessory Passenger Floorboard Kits Using Traditional D-Shaped Passenger Boards	\$79.99
------	--	---------



7523

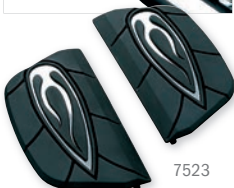

7523

FOR HARLEY-DAVIDSON®

NEW

FEATURED BIKES

COLLECTIONS

Audio

Lighting

Accessory Mounts

Handlebar Controls, Grips & Mirrors

Pegs & Foot Controls

Covers, Trims & Accents

Air Cleaners

Crusher

Exhaust

Air Cleaners

Performance Components

Touring & Comfort

Windshields & Air Management

Luggage Organizers & Storage Covers

INDEX



PEGS & FOOT CONTROLS FOOTPEGS, SHIFT PEGS & BRAKE PEDAL PADS



TRIDENT ISO

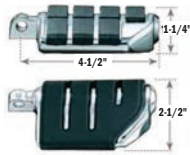

SMALL & LARGE TRIDENT ISO®-PEGS

All the features & comfort of the original ISO-Peg but with a whole new look! Coordinates well with stock or custom footrests. Already have ISO-Pegs? Then update them with a whole new style by adding the Trident Replacement Rubbers.

MULTI-FIT

Fits: See Fitment Chart Below

WITH MALE MOUNT ADAPTERS

7590	Small, Chrome (pr)	\$49.99
7560	Small, Gloss Black (pr)	\$49.99
7591	Large, Chrome (pr)	\$49.99
7561	Large, Gloss Black (pr)	\$49.99
7592	Dually, Chrome (pr)	\$79.99
7562	Dually, Gloss Black (pr)	\$79.99

WITHOUT MALE MOUNT ADAPTERS

7595	Small, Chrome (pr)	\$39.99
7565	Small, Gloss Black (pr)	\$39.99
7596	Large, Chrome (pr)	\$39.99
7566	Large, Gloss Black (pr)	\$39.99
7597	Dually, Chrome (pr)	\$69.99
7567	Dually, Gloss Black (pr)	\$69.99

TRIDENT ISO®-SHIFT PEGS

Perfectly matches other Trident products. The Longhorn is 5/8" longer than your stock shift peg for easier shifting.

FOR HARLEY-DAVIDSON®

Fits: All H-D Shift Levers

7593	Trident ISO-Shift Peg, Chrome (ea)	\$19.99
7558	Trident ISO-Shift Peg, Gloss Black (ea)	\$19.99
7594	Longhorn Trident ISO-Shift Peg, Chrome (ea)	\$19.99

REPLACEMENT RUBBER PADS & COMPONENTS

4338	For Large Trident ISO-Pegs (pr)	\$7.99
4390	For Trident Shift Peg (ea)	\$6.99
4391	For Longhorn Trident Shift Peg (ea)	\$6.99
4339	For Dually Trident ISO-Pegs (pr)	\$10.99
4345	For Small Trident ISO-Pegs (pr)	\$7.99

FITMENT CHART

WITH MALE MOUNT ADAPTERS

FOR HARLEY-DAVIDSON®

Fits: Universal Fitment for All Kuryakyn Male Mount Footpeg Clevises, Direct Replacement for H-D Style Male Mount Footpeg Applications (except '11-'17 XL1200C Sportster Custom, '12-'16 XL1200V Sportster Seventy-Two & '10-'17 XL1200X Sportster Forty-Eight)

WITHOUT MALE MOUNT ADAPTERS

FOR HARLEY-DAVIDSON®

Fits: OEM Stock Foot Peg Mount Location, Requires Model Specific Tapered (▲) or Splined (⚙) Adapters (Sold Separately) Found On Page 117

FOOTPEGS, SHIFT PEGS & BRAKE PEDAL PADS PEGS & FOOT CONTROLS

DELUXE ISO®-BRAKE PEDAL PADS

High-quality soft rubber wrapped in glistening chrome, this premium pedal looks good and is made to last. Installs easily using hidden fasteners.

FOR HARLEY-DAVIDSON®

7589	Fits: '80-'17 Electra Glides, Road Glides, Road Kings, Street Glides, Tour Glides & Trikes; '86-'17 FL Softail Models & '12-'16 Dyna Switchbacks (ea)	\$39.99
7588	Fits: All '84-'17 FX Softail Models, '08-'11 FXCW/C Rocker Models, '93-'17 FXDWG Dyna Wide Glide Models, '08-'17 FXDF Dyna Fat Bob Models with Forward Controls & All Kuryakyn Forward Controls (ea)	\$39.99



EXTENDED BRAKE PEDAL PADS

1-1/4" of additional length makes it easier to apply the rear brake. Add just an extension to your stock pad, or a complete assembly containing a brake pad with extension that is also available.

FOR HARLEY-DAVIDSON®

1078	Brake Pedal Pad Extension (ea) Fits: '06-'17 Street Glides (except '10-'12 & '15-'17 FLHXSE), '10-'13 & '15-'17 FLTRX/S Road Glides (except '12-'13 FLTRXSE), '04-'07 Road King Customs & Any Models Equipped with H-D's Streamliner Brake Pedal Pad (H-D P/N 42712-04)	\$29.99
7587	Premium Extended Brake Pedal Pad (ea) Fits: '80-'17 Electra Glides, Road Glides, Road Kings, Street Glides, Tour Glides & Trikes; '86-'17 FL Softail Models & '12-'16 Dyna Switchbacks	\$39.99

Note: Not compatible with fairing lowers on '04-earlier Touring Models.

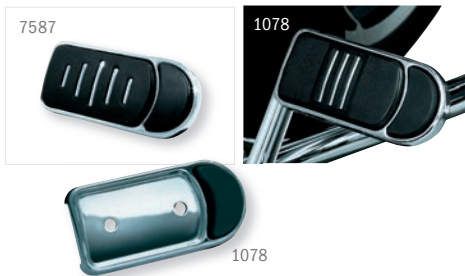
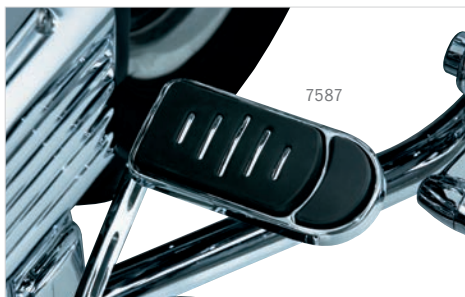

REPLACEMENT RUBBER PADS & COMPONENTS FOR ISO-FOOT CONTROLS

8077	ISO-Stirrup Mount, 5/8" Female (ea)	\$24.99
8079	ISO-Stirrup Mount, Male (ea)	\$24.99
8082	Replacement Pads for 8027 & 8857 (set)	\$10.99
8732	Replacement Locking Pins and Screw Kit for p/n 4467 & 4466 (kit)	\$9.99
8011	Replacement Pads for ISO - Shift Peg (set) Fits: Kuryakyn ISO- & Trident Shift Pegs	\$6.99
8081	Replacement Pads for 8029 & 4025 (set)	\$10.99
8083	Replacement Pads for 8044 (set)	\$11.99
8080	Replacement Pads for Stirrup Heel Rest (pr)	\$10.99
8078	Replacement Stirrup Arm (ea) Fits: Kuryakyn ISO-Stirrups, Right or Left	\$26.99

4454	Replacement Pads for ISO-Wings (set)	\$20.99
8010	Replacement Pads for Large ISO-Pegs (set)	\$12.99
8066	Bolt for Large ISO-Peg, Dually ISO-Peg, & ISO-Wing (ea)	\$2.99
4468	Replacement Rubber Pads for SwingWing Pegs (set)	\$20.99
4447	Replacement Curb Feelers for Switchblade Pegs (pr)	\$10.99
4448	Replacement Rubber Pads for Switchblade Peg (set)	\$18.99
8023	Replacement Pads for Dually ISO-Pegs (set)	\$17.99
8009	Replacement Pads for Small ISO-Pegs (set)	\$11.99

FOR HARLEY-DAVIDSON®

NEW

FEATURED BIKES

COLLECTIONS

Audio

Lighting

Accessory Mounts

Handlebar Controls, Grips & Mirrors

Pegs & Foot Controls

Covers, Trims & Accents

Air Cleaners

Crusher

Exhaust

Air Cleaners

Performance Components

Touring & Comfort

Windshields & Air Management

Luggage Organizers & Storage Covers

INDEX



PEGS & FOOT CONTROLS FLOORBOARDS & FLOORBOARD COVERS

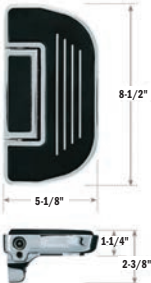

5 Mounting Positions!



PREMIUM & RIBBED FLOORBOARDS
FOR DRIVER OR PASSENGER
 U.S. Patent D653,174

Style, quality, function, and adjustability at a price that can't be beat. Switching to floorboards just got easier with five thoughtfully placed splined mounts. These boards can be fine tuned just right for the rider or passenger. (4-1/2" wide x 8-1/2" long)

MULTI-FIT

Fits: See Fitment Chart Below

4351	Chrome - Premium (pr) 🌸	\$199.99
4357	Wrinkle Black - Ribbed (pr) 🌸	\$159.99

REPLACEMENT COMPONENTS

4369	Replacement Premium Rubber Pads	\$49.99
4375	Replacement Ribbed Rubber Pads	\$29.99

Note: Floorboards are 8-1/2" x 4-1/2". Boards should not be installed in place of a footpeg on a peg mount secured with a single fastener and no anti-rotation mechanism. The board will apply too much force and loosen the mount from the bike.



7553

PREMIUM FLOORBOARD INSERTS
FOR DRIVER & PASSENGER

Our Premium Inserts for Driver Floorboards ride on rubber isolators to keep your feet buzz-free. The cushy inserts for Passenger Boards pop right in place of the stock pads. They'll look great on any bike using H-D's Traditional or Half Moon shape driver boards & D-shaped passenger boards.

FOR HARLEY-DAVIDSON®

7553	Premium Inserts for H-D Traditional Driver Boards (pr) Fits: '84-'17 Electra Glides (except '04-'05 FLHTCSE, '06-'13 FLHTCUSE, '14-'17 FLHTKSE), '98-'09 Road Glides (except '09 FLTRSE), '11-'13 & '16-'17 Road Glide Ultras (except '11 & '15-'16 FLTRUSE), '94-'17 Road Kings (except '04-'07 FLHRS, '07-'08 & '13-'14 FLHRSE), '84-'96 Tour Glides, '09-'17 Trikes, '86-'08 FLST/FLSTC, '90-'17 FLSTF, '93-'96 FLSTN, '97-'03 FLSTS, '05-'07 FLSTSC & '12-'16 FLD Dyna Switchback	\$89.99
------	--	---------

FITMENT CHART

WITH MALE MOUNT ADAPTERS

FOR HARLEY-DAVIDSON®

Fits: Universal Fitment for All Kuryakyn Male Mount Footpeg Clevises, Direct Replacement for H-D Style Male Mount Footpeg Applications (except '11-'17 XL1200C Sportster Custom, '12-'16 XL1200V Sportster Seventy-Two & '10-'17 XL1200X Sportster Forty-Eight)

WITHOUT MALE MOUNT ADAPTERS

FOR HARLEY-DAVIDSON®

Fits: OEM Stock Foot Peg Mount Location, Requires Model Specific Tapered (▲) or Splined (🌸) Adapters (Sold Separately) Found On Page 117

7554	Premium Inserts for H-D D-Shaped Passenger Boards (pr) Fits: '86-17 Electra Glides, Road Glides, Road Kings, Tour Glides & Trikes with Traditional D-Shaped Passenger Boards; '86-'17 Softail or '06-'17 Dyna Models equipped with H-D Accessory Passenger Floorboard Kits Using Traditional D-Shaped Passenger Boards	\$79.99
------	---	---------

FOOTPEGS, SHIFT PEGS & BRAKE PEDAL PADS PEGS & FOOT CONTROLS

3 Mounting Options



PREMIUM MINI BOARDS

These compact boards combine the size and convenience of a peg with the comfort of a full-sized floorboard. 5-1/2" long x 4" wide and styled to complement our Premium and Trident lines so you can still ride in comfort without sacrificing style. Utilizing splined adapters, the boards can be positioned forward, back, or center at almost any angle. Also a great option for Driver Cruise Pegs!

MULTI-FIT

Fits: See Fitment Chart Left

WITH MALE MOUNT ADAPTERS

4392	Chrome (pr)	\$109.99
7578	Gloss Black (pr)	\$109.99

WITHOUT MALE MOUNT ADAPTERS

4393	Chrome (pr)	\$99.99
7579	Gloss Black (pr)	\$99.99



MORE OPTIONS

PASSENGER FLOORBOARD MOUNTS
PG 118



BAHN™ PEGS

The flattened top and coordinating end caps are forged and machined aluminum engineered for increased surface area to support your boots, while soft rubber inserts provide reduced vibration for a seamless blend of unmatched style and function.

FOR HARLEY-DAVIDSON™

Fits: See Fitment Chart Left

WITH MALE MOUNT ADAPTERS

6959	Chrome (pr)	\$139.99
6958	Tuxedo (pr)	\$139.99

BAHN™ BRAKE PEDAL PAD

Replace the stock rubber brake pad in minutes with this easy-to-install forged aluminum piece. Features a premium rubber surface that helps eliminate boot slippage on your brake pad.

FOR HARLEY-DAVIDSON™

Fits: '80-'17 Electra Glides, Road Glides, Road Kings, Street Glides, Tour Glides & Trikes; '86-'17 FL Softail Models & '12-'16 Dyna Switchbacks

9694	Chrome (ea)	\$64.99
1094	Tuxedo (ea)	\$64.99



FOR HARLEY-DAVIDSON®

NEW

FEATURED BIKES

COLLECTIONS

Audio

Lighting

Accessory Mounts

Handlebar Controls, Grips & Mirrors

Pegs & Foot Controls

Covers, Trims & Accents

Air Cleaners

Crusher

Exhaust Air Cleaners

Performance Components

Touring & Comfort

Windshields & Air Management

Luggage Organizers & Storage Covers

INDEX



PEGS & FOOT CONTROLS FOOTPEGS, SHIFT PEGS & BRAKE PEDAL PADS

ISO

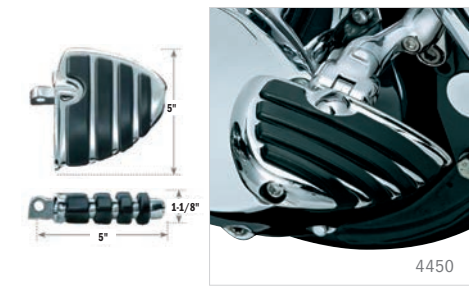
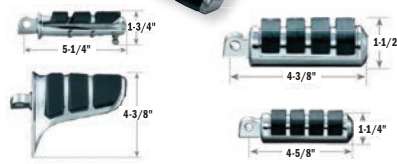

ISO® -PEGS

The industry's most comfortable footpegs!

MULTI-FIT

Fits: See Fitment Chart Below

WITH MALE MOUNT ADAPTERS

8000	Small (pr)	\$49.99
8024	Small Longhorn with 1" Extension (pr)	\$54.99
8002	Large (pr)	\$49.99
8025	Large Longhorn with 1" Extension (pr)	\$59.99
8028	Dually (pr)	\$79.99
4463	SweptWing (pr)	\$79.99

WITHOUT MALE MOUNT ADAPTERS

7964	Small (pr)	\$39.99
7965	Large (pr)	\$39.99
7963	Dually (pr)	\$69.99
4464	SweptWing (pr)	\$69.99

ISO®-PEGS WITH FEMALE MOUNT

FOR HARLEY-DAVIDSON®

Fits: H-D Applications Requiring 5/8" Female Mount Pegs

8001	5/8" Female Mount Small ISO-Pegs (pr)	\$49.99
8003	Bullet Style Female Mount Large ISO-Pegs (pr)	\$49.99

ISO®-WING MINI BOARDS

The ISO-Wing has the greatest surface area of any of our ISO offerings to date.



MULTI-FIT

Fits: See Fitment Chart Below

WITH MALE MOUNT ADAPTERS

4450	Chrome (pr)	\$109.99
7563	Gloss Black (pr)	\$109.99

WITHOUT MALE MOUNT ADAPTERS

4452	Chrome (pr)	\$99.99
7568	Gloss Black (pr)	\$99.99

FITMENT CHART

WITH MALE MOUNT ADAPTERS

FOR HARLEY-DAVIDSON®

Fits: Universal Fitment for All Kuryakyn Male Mount Footpeg Clevises, Direct Replacement for H-D Style Male Mount Footpeg Applications (except '11-'17 XL1200C Sportster Custom, '12-'16 XL1200V Sportster Seventy-Two & '10-'17 XL1200X Sportster Forty-Eight)

WITHOUT MALE MOUNT ADAPTERS

FOR HARLEY-DAVIDSON®

Fits: OEM Stock Foot Peg Mount Location, Requires Model Specific Tapered (▲) or Splined (⚙) Adapters (Sold Separately) Found On Page 117

FOOTPEGS, SHIFT PEGS & BRAKE PEDAL PADS PEGS & FOOT CONTROLS

SWINGWING PEGS U.S. Patent D560,562

A convenient fold-forward, comfortable cruise peg that fastens in place of your stock peg and provides a secondary fold-out peg 3" forward.

MULTI-FIT

Fits: See Fitment Chart Left

4466 SwingWing Pegs with Male Mount Adapter (pr) \$169.99

4467 SwingWing Pegs without Male Mount Adapter (pr) ▲ \$159.99

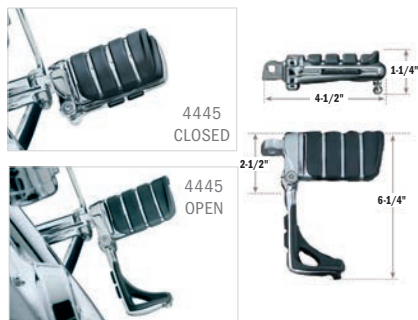

SWITCHBLADE PEGS U.S. Patents D506,707 & 6,893,038

In their standard compact mode, they are a large-surface-area, rubber-isolated footpeg. Deploy the concealed heel rest and now you have the added fatigue-fighting comfort of the famous Kuryakyn ISO-Stirrups. Although this setup will work in any peg location, these are the ideal footpegs for bikes using forward controls or as forward-mounted cruise pegs.

MULTI-FIT

Fits: See Fitment Chart Left

4445 Switchblade Pegs with Male Mount Adapter (pr) \$139.99

4446 Switchblade Pegs without Male Mount Adapter (pr) ✳ \$129.99

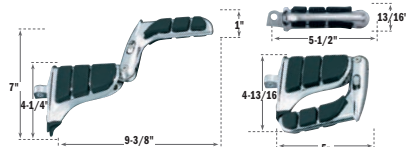

ISO®-PEG STIRRUPS WITH MALE MOUNT ADAPTERS

We added a heel rest to our popular ISO-Pegs to give you floorboard-like comfort without the added bulk.

MULTI-FIT

Fits: See Fitment Chart Left

8074 ISO-Stirrups without Pegs (pr) \$99.99

8076 ISO-Stirrups with Small ISO-Pegs (pr) \$129.99

8075 ISO-Stirrups with Large ISO-Pegs (pr) \$129.99

8062 ISO-Stirrups with Dually Pegs (pr) \$139.99

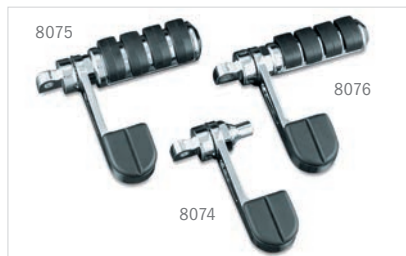

ISO®-STIRRUPS FOR H-D CUSTOM PEGS

Quick and easy to install, simply remove the male mount from the peg and replace it with the stirrup assembly.

FOR HARLEY-DAVIDSON®

See Kuryakyn.com for specific H-D compatible part numbers

4554 Fits: 1-3/4" Shaft (pr) \$109.99

4555 Fits: 3-5/8" Shaft (pr) \$109.99

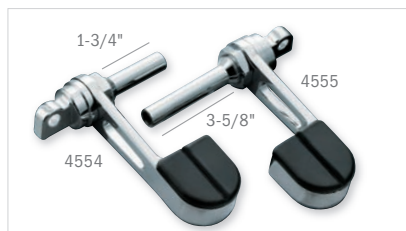

ISO®-STIRRUPS WITHOUT MALE MOUNT ADAPTERS

The unbelievable comfort of our stirrup heel rests allow floorboard-like support to reduce fatigue on longer rides.

MULTI-FIT

Fits: See Fitment Chart Left

4028 ISO-Stirrups without Male Mount Adapters (pr) \$89.99

Note: Compatible with Large ISO-Pegs, Dually ISO-Pegs, Retro Pegs, SweptWing Pegs, Large Trident Pegs, Dually Trident Pegs & Flamin' Pegs.



FOR HARLEY-DAVIDSON®

NEW

FEATURED BIKES

COLLECTIONS

Audio

Lighting

Accessory Mounts

Handlebar Controls, Grips & Mirrors

Pegs & Foot Controls

Covers, Trims & Accents

Air Cleaners

Crusher

Exhaust

Air Cleaners

Performance Components

Touring & Comfort

Windshields & Air Management

Luggage Organizers & Storage Covers

INDEX

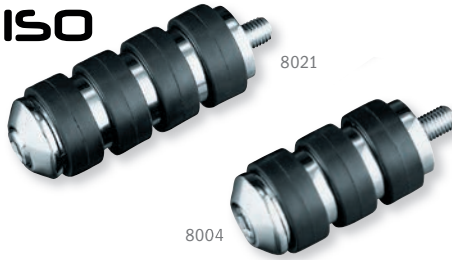

PEGS & FOOT CONTROLS FOOTPEGS, SHIFT PEGS & BRAKE PEDAL PADS**ISO****STANDARD & LONGHORN ISO®-SHIFT PEGS**

Standard is stock-like in size; the Longhorn has one more O-ring and is 5/8" longer (great for extended controls).

FOR HARLEY-DAVIDSON®

Fits: All H-D Shift Levers

8004	Standard ISO-Shift Peg (ea)	\$19.99
8021	Longhorn ISO-Shift Peg (ea)	\$19.99

ISO®-BRAKE PEDAL PAD

Designed to coordinate beautifully with our ISO-Pegs and ISO-Grips, these ISO-Brake Pedal Pads complete the look.

FOR HARLEY-DAVIDSON®

8027	ISO-Extended Brake Pedal Pad (ea) Fits: '80-'17 Electra Glides, Road Glides, Road Kings, Street Glides, Tour Glides & Trikes; '86-'17 FL Softail Models & '12-'16 Dyna Switchbacks (ea)	\$39.99
8029	ISO-Extended Brake Pedal Pad (ea) Fits: All '84-'17 FX Softail Models, '08-'11 FXCW/C Rocker Models, '93-'17 FXDWG Dyna Wide Glide Models, '08-'17 FXDF Dyna Fat Bob Models with Forward Controls & All Kuryakyn Forward Controls (ea)	\$29.99
8044	Longhorn Brake Pedal Pad (ea) Fits: All '84-'17 FX Softail Models, '08-'11 FXCW/C Rocker Models, '93-'17 FXDWG Dyna Wide Glide Models, '08-'17 FXDF Dyna Fat Bob Models with Forward Controls & All Kuryakyn Forward Controls	\$39.99
4456	ISO-Extended Brake Pedal Pad (ea) Fits: '80-'17 Electra Glides, Road Glides, Road Kings, Street Glides, Tour Glides & Trikes; '86-'17 FL Softail Models & '12-'16 Dyna Switchbacks	\$39.99
8022	ISO-Brake Pedal Cover (ea) Fits: H-D: '99-'09 XL883C Sportster Custom, '99-'17 XL1200C Sportster Custom, '10-'17 XL1200X Sportster Forty-Eight, '12-'16 XL1200V Sportster Seventy-Two, '03-'08 & '10-'17 FXDWG Dyna Wide Glide, '08-'17 FXDF Fat Bob with Forward Controls, '02-'06 VRSCA V-Rod, '04-'05 VRSCB V-Rod, '07-'10 VRSCAW V-Rod, '07-'17 VRSCDX Night Rod Special, '07 VRSCX V-Rod Limited Edition, '09-'17 VRSCF V-Rod Muscle	\$34.99

**MORE OPTIONS**

DELUXE ISO®-BRAKE
PEDAL PAD
PG 109

**FITMENT CHART****WITH MALE MOUNT ADAPTERS****FOR HARLEY-DAVIDSON®**

Fits: Universal Fitment for All Kuryakyn Male Mount Footpeg Clevises, Direct Replacement for H-D Style Male Mount Footpeg Applications (except '11-'17 XL1200C Sportster Custom, '12-'16 XL1200V Sportster Seventy-Two & '10-'17 XL1200X Sportster Forty-Eight)

WITHOUT MALE MOUNT ADAPTERS**FOR HARLEY-DAVIDSON®**

Fits: OEM Stock Foot Peg Mount Location, Requires Model Specific Tapered (▲) or Splined (⚙️) Adapters (Sold Separately) Found On Page 117

FLOORBOARDS & FLOORBOARD COVERS PEGS & FOOT CONTROLS

ISO®-BOARDS FOR DRIVER & PASSENGER

ISO-Boards are a great-looking and comfortable alternative to the lackluster original equipment floorboards. Rubber ISO-ribs run the full length of the board, providing both traction and comfort. Longer than stock length offers more room on hauls.

FOR HARLEY-DAVIDSON®

COMBO SET

7902	Combo Set - 7905 ISO-Boards & 7906 ISO-Passenger Boards (set) Fits: '93-'17 Electra Glides, '94-'17 Road Kings (except, '04-'07 FLHRS, '02-'03, '07-'08, '13-'14 FLHRSE), '98-'17 Road Glides (except '00-'01, '09 FLTRSE, '10-'13 FLTRX & '12-'13 FLTRXSE), '93-'96 Tour Glides, '09-'17 Trikes and '86-'17 FL Softail Models & '12-'16 Dyna Switchback with H-D Accessory Passenger Floorboard Kits	\$399.99
------	--	----------

FOR DRIVER OR PASSENGER

7906	ISO-Passenger Boards (pr) Fits: '93-'17 Electra Glides, '98-'09 Road Glides (except '00-'01 & '09 FLTRSE), '11-'13 & '16-'17 FLTRU Road Glide Ultras, '94-'17 Road Kings (except, '04-'07 FLHRS; '02-'03, '07-'08 & '13-'14 FLHRSE), '93-'96 Tour Glides, '09-'17 Trikes and '86-'17 Softail & '06-'17 Dyna Models with H-D Accessory Passenger Floorboard Kits	\$189.99
7905	ISO-Boards (pr) Fits: '83-'17 Electra Glides, Road Glides, Road Kings, Street Glides, Tour Glides, Trikes, '86-'17 FL Softail Models & '12-'16 Dyna Switchback	\$299.99

ISO®-BOARD CONVERSIONS FOR DRIVER OR PASSENGER

These kits include our finely chromed ISO-Boards and a cast bracket to connect the board to the slip-resistant splined adapter (sold separately).

MULTI-FIT

Fits: See Fitment Chart Left 

7916	ISO-Board Conversions for Driver or Passenger (pr)	\$199.99
4455	ISO-Board Conversions for Passenger (pr)	\$219.99

Note: Boards should not be installed in place of a footpeg on a peg mount secured with a single fastener and no anti-rotation mechanism. The board will apply too much force and loosen the mount from the bike. Passenger applications for Softail and Dyna requires Anti-Rotation Floorboard Mounts for installation. Installation on other models in place of a male mount footpeg requires P/N 8883.



7905



7902



7906



7905



7916



4455

DETERMINE THE STYLE THAT BEST FITS YOUR APPLICATION:

P/N 4455 is recommended for Passenger use only; bracket design elevates board above existing peg location about 1-1/4".



4455 CONFIGURATION

P/N 7916 can be used for Driver or Passenger. Verify operation of existing shift lever & brake pedal will not be adversely effected by installation.



7916 CONFIGURATION

FOR HARLEY-DAVIDSON®

NEW

FEATURED BIKES

COLLECTIONS

Audio

Lighting

Accessory Mounts

Handlebar Controls, Grips & Mirrors

Pegs & Foot Controls

Covers, Trims & Accents

Air Cleaners

Crusher

Exhaust

Air Cleaners

Performance Components

Touring & Comfort

Windshields & Air Management

Luggage Organizers & Storage Covers

INDEX



PEGS & FOOT CONTROLS FOOTPEGS, SHIFT PEGS & BRAKE PEDAL PADS



4425

PILOT™ PEGS

Dampen vibration and add style.

MULTI-FIT

Fits: See Fitment Chart Below

WITH MALE MOUNT ADAPTERS

4425	Pilot Pegs (pr)	\$69.99
4430	Mini Pilot Peg (pr)	\$45.99

WITHOUT MALE MOUNT ADAPTERS 🌸

4419	Pilot Pegs (pr)	\$59.99
------	-----------------	---------

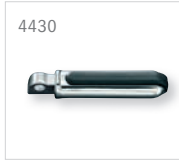

4430



4428

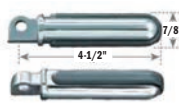

4-1/2"



7/8"

PILOT™ PEG STIRRUPS

Our stirrup arm, with its smooth radius & built-in heel guard, prevents melting the heel of your boot on the front pipe when resting your weary ridin' feet.

FOR HARLEY-DAVIDSON®

Fits: Typical Male Mount Cruise Peg Applications; See Fitment Chart Below

4428	Pilot Pegs with Stirrups (pr)	\$139.99
------	-------------------------------	----------

PILOT™ SHIFT PEGS

The Pilot Pegs' flowing teardrop profile complements the shape of components found on some of today's cutting-edge customs.

FOR HARLEY-DAVIDSON®

Fits: All H-D Shift Levers

4426	Pilot Shift Peg (ea)	\$19.99
------	----------------------	---------



4430

PILOT™ BRAKE PEDAL PAD

Our transforming full-coverage brake pedal pad flows with a teardrop profile while complementing the shape of components found on some of today's cutting-edge customs.

FOR HARLEY-DAVIDSON®

Fits: All '84-'17 FX Softail Models, '08-'11 FXCW/C Rocker Models, '93-'17 FXDWG Dyna Wide Glide Models, '08-'17 Dyna Fat Bob Models with Forward Controls & All Kuryakyn Forward Controls

4429	Pilot Brake Pedal Pad (ea)	\$32.99
------	----------------------------	---------



4426



4429

REPLACEMENT RUBBER PADS

4434	For Mini Pilot Peg (set)	\$10.99
4433	For Pilot Brake Pedal Pad (set)	\$10.99
4431	For Pilot Pegs (set)	\$15.99
4432	For Pilot Stirrups or Shift Peg (set)	\$9.99

FITMENT CHART

WITH MALE MOUNT ADAPTERS

FOR HARLEY-DAVIDSON®

Fits: Universal Fitment for All Kuryakyn Male Mount Footpeg Clevises, Direct Replacement for H-D Style Male Mount Footpeg Applications (except '11-'17 XL1200C Sportster Custom, '12-'16 XL1200V Sportster Seventy-Two & '10-'17 XL1200X Sportster Forty-Eight)

WITHOUT MALE MOUNT ADAPTERS

FOR HARLEY-DAVIDSON®

Fits: OEM Stock Foot Peg Mount Location, Requires Model Specific Tapered (▲) or Splined (🌸) Adapters (Sold Separately) Found On Page 117

FOOTPEG & FLOORBOARD ADAPTERS PEGS & FOOT CONTROLS

KURYAKYN FOOTRESTS ARE MODULAR & UTILIZE EITHER A TAPERED (▲) OR SPLINED (✱) ADAPTER THAT FITS YOUR SPECIFIC APPLICATION. REQUIRED ADAPTER IS LISTED BY EACH PEG, BOARD, OR MINBOARD ON PAGES 98-116. (SOLD SEPARATELY)

SPLINED ADAPTERS ✱

Splined Adapters required to mount Kuryakyn Pegs, Boards, and Mini Boards without adapters.

FOR HARLEY-DAVIDSON™

FRONT APPLICATIONS

8884	Splined Peg Adapters for XL, Chrome Fits: '10-'17 XL1200X Forty-Eight, '11-'17 XL1200C 1200 Custom & '12-'16 XL1200V Seventy-Two (pr)	\$26.99
8886	Splined Peg Adapters for XL, Gloss Black (pr) Fits: '10-'17 XL1200X Forty-Eight, '11-'17 XL1200C 1200 Custom & '12-'16 XL1200V Seventy-Two	\$26.99

FRONT OR REAR APPLICATIONS

8883	Non-Pivoting Splined Male Mount Adapters, Chrome (pr) Fits: All H-D Style Male Mount Peg Applications (except '16-'17 FLHX/S, '16-'17 FLTRX/S, '06-'17 Dyna Passenger Location & '10-'17 XL1200C, XL1200X, XL1200V) Note: Non-Pivoting design intended for Kuryakyn floorboards P/N's 4351, 4357, 4455 & 7916.	\$26.99
8881	Splined Peg Adapters, Chrome (pr) Fits: All H-D Style Male Mount Peg Applications, Typical Male Mount Cruise Peg Applications for Kuryakyn Pegs That Accept Splined Adapters Note: Except Driver Peg Location on '10-'17 XL1200X Forty-Eight, '11-'17 XL1200C 1200 Custom , '12-'16 XL1200V Seventy-Two	\$26.99
8888	Splined Peg Adapters, Gloss Black (pr) Fits: All H-D Style Male Mount Peg Applications, Typical Male Mount Cruise Peg Applications for Kuryakyn Pegs That Accept Splined Adapters Note: Except Driver Peg Location on '10-'17 XL1200X Forty-Eight, '11-'17 XL1200C 1200 Custom , '12-'16 XL1200V Seventy-Two	\$26.99

TAPERED ADAPTERS ▲

Tapered Adapters required to mount Kuryakyn Pegs, Boards, and Mini Boards without adapters.

FOR HARLEY-DAVIDSON™

FRONT APPLICATIONS

8882	Fits: '04-'10 Big Dog Motorcycles (pr)	\$31.99
8885	Fits: '10-'17 XL1200X Forty-Eight, '11-'17 XL1200C 1200 Custom & '12-'16 XL1200V Seventy-Two (pr)	\$26.99
8887	Tapered Peg Adapters for XL, Gloss Black (pr) Fits: '10-'17 XL1200X Forty-Eight, '11-'17 XL1200C 1200 Custom & '12-'16 XL1200V Seventy-Two	\$26.99

FRONT OR REAR APPLICATIONS

8880	H-D Style Male Mount Applications (pr) Note: (except Driver Peg Location on '10-'17 XL1200X Forty-Eight, '11-'17 XL1200C 1200 Custom , '12-'15 XL1200V Seventy-Two)	\$26.99
8008	Kuryakyn Pegs Accepting Tapered Adapters - H-D Style Male Mount Applications (pr) Note: (except Driver Peg Location on '10-'17 XL1200X Forty-Eight, '11-'17 XL1200C 1200 Custom , '12-'16 XL1200V Seventy-Two)	\$19.99
8890	Peg Adapters, Male Mount, Gloss Black (pr) Fits: Kuryakyn Pegs Accepting Tapered Adapters - H-D Style Male Mount Applications Note: (except Driver Peg Location on '10-'17 XL1200X Forty-Eight, '11-'17 XL1200C 1200 Custom , '12-'16 XL1200V Seventy-Two)	\$26.99



FOR HARLEY-DAVIDSON®

NEW

FEATURED BIKES

COLLECTIONS

Audio

Lighting

Accessory Mounts

Handlebar Controls, Grips & Mirrors

Pegs & Foot Controls

Covers, Trims & Accents

Air Cleaners

Crusher

Exhaust

Air Cleaners

Performance Components

Touring & Comfort

Windshields & Air Management

Luggage Organizers & Storage Covers

INDEX



PEGS & FOOT CONTROLS FOOTPEG & FLOORBOARD RELOCATORS



4371

ANTI-ROTATION PASSENGER FLOORBOARD MOUNTS FOR SOFTAIL

Now you can add floorboards to your Softail without the chance of them rotating or coming loose down the road. Interlocking teeth make adjustments simple and precise.



4371

FOR HARLEY-DAVIDSON®

4371 Fits: '07-'17 FLSTN, '08-'11 FLSTSB & '12-'17 FLS with Stock Rear Exhaust Support Bracket (set) \$79.99

Note: If stock exhaust system & rear support bracket has been removed & replaced by a staggered dual or 2-1 system, use P/N 4372 or 4374.

4372 Fits: '08-'17 FLSTC, '08-'10 FXSTC, '08-'09 FXSTB, '10 FLSTSE (set) \$79.99

Note: Will also fit '08-'16 FLSTN, FLSTF, FLSTFB, FLSTSB & FXSTSSE if the stock exhaust & rear support bracket has been removed & replaced with a staggered dual or 2-1 system.

4374 Fits: '00-'07 FLSTC, '06 FLST, '00-'07 FXST & FXSTB, '07 FXSTC, '00-'06 FXSTS (set) \$79.99

Note: Will also fit '05-'06 FLSTN, '00-'07 FLSTF, & '07 FXSTSSE if the stock exhaust & rear support bracket has been removed & replaced with a staggered dual or 2-1 system.



4372



4372



**MORE OPTIONS
PREMIUM FLOORBOARDS
PG 110**



4330

PASSENGER BOARD MOUNTS FOR DYNA

Eliminate the oddly angled position encountered if installing boards to the stock mounts. The splined interface allows installation of our boards by themselves, or combined with our Retractable Passenger Pegs for ultimate touring comfort.

FOR HARLEY-DAVIDSON®

4330 Passenger Board Mounts (pr) \$99.99
Fits: '06-'17 Dyna Models

Note: For use with Kuryakyn Boards P/N's 4351 or 4357 and/or Retractable Passenger Pegs, P/N's 4388 or 4389.



8064

MALE MOUNT FOOTPEG EXTENSIONS

Need more room? Our ISO-Peg Extensions are made of machined steel and are then chrome plated.

MULTI-FIT

Fits: Kuryakyn Pegs Accepting Tapered Adapters, For Mounting to Typical Cruise Peg Applications

8063 Male Mount Footpeg Extensions, 1-1/2" (pr) \$39.99

8064 Male Mount Footpeg Extensions, 2-1/2" (pr) \$39.99

Note: For use as extension from Male Mount Clevis. Pegs sold separately.



8063

FOOTPEG & FLOORBOARD RELOCATORS PEGS & FOOT CONTROLS

FOOTPEG & STIRRUP EXTENDERS

Protect those new boots from melting all over your front pipe. These slick extenders put another couple inches between you and your bike.



8043

MULTI-FIT

Fits: Universal Fitment for Typical Male Mount Cruise Peg Applications

8041 Footpeg & Stirrup Extenders, 2-1/4" (pr) \$41.99

8043 Footpeg & Stirrup Extenders, 1-1/4" (pr) \$39.99

Note: Direct Replacement for H-D Style Male Mount Footpeg Applications (except '11-'17 XL1200C Sportster Custom, '12-'16 XL1200V Sportster Seventy-Two & '10-'17 XL1200X Sportster Forty-Eight).

FEMALE PEG ADAPTERS

Female Peg Adapters for Kuryakyn pegs accepting tapered adapters.

FOR HARLEY-DAVIDSON®

Fits: Kuryakyn Pegs Accepting Tapered Adapters - Fits 5/8" Square Peg Mounts

8007 Female for 5/8" Square Mounts (pr) \$10.99

8006 Female for Bullet Style Mounts (pr) \$10.99

ENDS & BOLTS

Model-specific adapters and bolts for footpeg fitment.

MULTI-FIT

Fits: Kuryakyn Large ISO-, Dually ISO-, ISO-Wing, Large Trident & Dually Trident Pegs

8066 Bolt for Large ISO-Peg, Dually ISO-Peg, & ISO-Wing (ea) \$2.99

CHROME FOOTPEG MOUNTING HARDWARE

Grade 5 steel footpeg hardware in glistening chrome.

FOR HARLEY-DAVIDSON®

7943 Chrome Footpeg Mounting Hardware (pr) \$8.99

Note: 3/8"-24 X 1-1/2" Bolts With Nuts & Spring Washers.

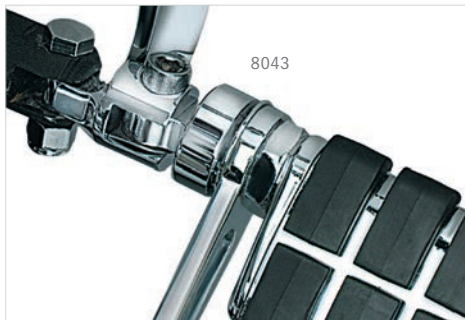

8043



8006

8007

8008
PG 117

8066



7943



FOR HARLEY-DAVIDSON®

NEW

FEATURED BIKES

COLLECTIONS

Audio

Lighting

Accessory Mounts

Handlebar
Controls, Grips
& Mirrors

Pegs & Foot
Controls

Covers, Trims
& Accents

Air Cleaners

Crusher

Exhaust
Air Cleaners
Performance
Components

Touring &
Comfort

Windshields &
Air Management

Luggage Organizers
& Storage Covers

INDEX



PEGS & FOOT CONTROLS FOOTPEG & FLOORBOARD RELOCATORS



FLOORBOARD RELOCATION BRACKETS

FOR DRIVER BOARDS

- Repositions driver boards out 1" and forward 1" from stock location
- Makes a noticeable difference in comfort; thighs aren't as tight against the tank, right knee is not as tight against the air cleaner, and legs get to stretch out a little bit more
- Compatible with Kuryakyn ISO-Boards as well as H-D Traditional or SweptWing shaped boards

FOR HARLEY-DAVIDSON®

4588	Fits: '97-'16 Electra Glides (except '15-'16 FLHTKSE), Road Glides (except '15-'16 FLTRUSE), Road Kings, Street Glides (except '15-'16 FLHXSE) & '09-'13 Trikes (set)	\$99.99
------	---	---------

7528	Fits: '00-'17 FL Softail Models (set)	\$89.99
------	---------------------------------------	---------

Note: Not compatible with Cruise Arm Mark III, P/N's 7914, 7915, or Standard Length Cruise Arm Mark IV, P/N 7840.

Note: Not for use with fairing lowers.



MORE OPTIONS
KINETIC™ FLOORBOARD
INSERTS
PG 103



DRIVER FLOORBOARD SPACERS

Move your stock driver boards outward 3/4".

FOR HARLEY-DAVIDSON®

7509	Driver Floor Board Spacers for '09-'17 Touring (set) Fits: '09-'16 Electra Glides, Road Glides, Road Kings, Street Glides & '09-'13 Trikes	\$39.99
------	---	---------

450	Driver Floor Board Spacers, '92-'08 Touring (set) Fits: '92-'08 Electra Glides, Road Glides, Road Kings, Street Glides & Tour Glides	\$39.99
-----	---	---------

Note: Not compatible with Chrome Display Stand (H-D P/N 99002-97).

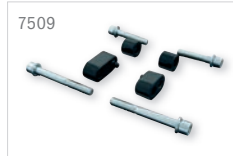

FLOORBOARD EXHAUST BOOT GUARDS

FOR TRADITIONAL DRIVER BOARDS U.S. Patent D618,597

Protect your boots from your exhaust pipe. Easy to install.

FOR HARLEY-DAVIDSON®

Fits: '84-'17 Electra Glides (except '04-'05 FLHTCSE & '06-'13 FLHTCUSE, '14-'17 FLHTKSE), '98-'09 Road Glides (except '09 FLTRSE), '11-'13 & '16-'17 Road Glide Ultras (except '11 FLTRUSE), '94-'17 Road Kings (except '04-'07 FLHRS, '07-'08 & '13-'14 FLHRSE), '84-'96 Tour Glides, '09-'17 Trikes, '86-'08 FLST/FLSTC, '90-'17 FLSTF, '93-'96 FLSTN, '97-'03 FLSTS, '05-'07 FLSTSC & '12-'16 FLD Dyna Switchback

7544	Right Side (ea)	\$39.99
------	-----------------	---------

PASSENGER PEGS: FIXED & ADJUSTABLE PEGS & FOOT CONTROLS



RETRACTABLE PASSENGER PEGS

FOR STREET GLIDE & ROAD GLIDE CUSTOM

U.S. Patents D653,175 & 8,870,207

Designed to transform a bike equipped with uncomfortable stock rear footpegs to a comfortable two-up touring machine.

FOR HARLEY-DAVIDSON®

Fits: '10-'13 & '15-'17 FLTRX/S; '00-'01 & '09 FLTRSE; '12-'13 FLTRXSE; '04-'07 FLHRS/I; '02-'03, '07-'08 & '13-'14 FLHRSE; '06-'17 FLHX/I/S, '10-'12 & '15-'17 FLHXSE & '15-'16 FLHTCUL

4352 Retractable Passenger Pegs (pr) \$199.99

Note: P/N 4352 will fit all '93-'13 Touring Models for customers wishing to remove passenger boards & convert to pegs.

Note: Will fit all '93-'17 Touring Models for customers wishing to remove passenger boards & convert to pegs.



RETRACTABLE PASSENGER PEGS

U.S. Patent D653,175 & Patent Pending

Transform an uncomfortable stock rear footpeg into an additional and comfortable alternate peg position. Two kits are available; P/N 4389 includes pegs for both the primary and cruise position. P/N 4388 includes a peg for cruise position, but is set up to accept our Premium or Ribbed Floorboards (P/N's 4351 or 4357), sold separately.

MULTI-FIT

Fits: OEM Stock Rear Footpeg Mount Location, Requires Model Specific Splined Adapter

4388 Retractable Passenger Pegs with Mount \$169.99
for Floorboards (pr)

4389 Retractable Passenger Pegs with Pegs (pr) \$189.99



REPLACEMENT COMPONENTS FOR RETRACTABLE PASSENGER PEGS

MULTI-FIT

4337 Clevis Assembly (ea) \$17.99
Fits: Kuryakyn P/N 4352 & 4389

4336 Tension Nut Service Kit (pr) \$14.99
Fits: Kuryakyn P/N's 4352, 4388 or 4389

4376 Replacement Tapered Peg Mount with Screw for 4352, 4353, 4388 & 4389 (ea) \$9.99
Fits: Kuryakyn P/N's 4352, 4353, 4388 & 4389

FOR HARLEY-DAVIDSON®

NEW

FEATURED BIKES

COLLECTIONS

Audio

Lighting

Accessory Mounts

Handlebar
Controls, Grips
& Mirrors

Pegs & Foot
Controls

Covers, Trims
& Accents

Air Cleaners

Crusher

Exhaust
Air Cleaners
Performance
Components

Touring &
Comfort

Windshields &
Air Management

Luggage Organizers
& Storage Covers

INDEX



PEGS & FOOT CONTROLS PASSENGER PEGS: FIXED & ADJUSTABLE

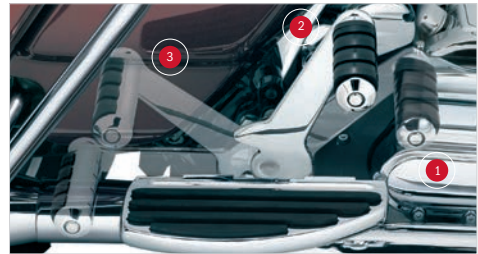
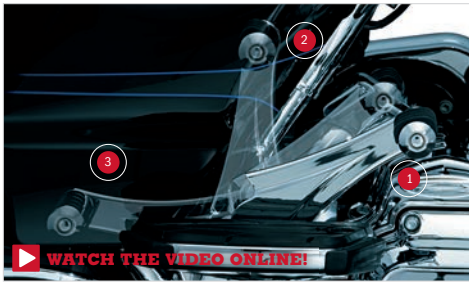









Three Positions For Ultimate Comfort!

ADJUSTABLE PASSENGER PEGS

Give your passenger multiple foot placement options, much like a highway cruise peg for riders. The Adjustable Passenger Pegs bolt onto your bike's existing rear floorboard mount, retaining all functions of the stock floorboards with the added benefit of new higher and farther-forward riding positions. By providing relief from the fatigue caused by the limitations of stock floorboards, the Adjustable Passenger Pegs are a must-have for two-up travelers.

STANDARD APPLICATIONS

PASSENGER BOARD MOUNT TYPE	FITMENT/APPLICATION	P/N	PRICE
 	'10-'17 Electra Glides (except '10-'13 FLHTCUSE, '14-'17 FLHTKSE, '15-'17 FLHTKL, '15-'16 FLHTCUL), '11-'13 & '16-'17 Road Glide Ultras (except '11 & '15-'16 FLTRUSE), '10-'17 Road Kings (except '13-'14 FLHRSE) & '10-'17 Trikes	4353	\$199.99
 	'10-'17 Electra Glides (except '10-'13 FLHTCUSE, '14-'17 FLHTKSE, '15-'17 FLHTKL, '15-'16 FLHTCUL), '11-'13 & '16-'17 Road Glide Ultras (except '11 & '15-'16 FLTRUSE), '10-'17 Road Kings (except '13-'14 FLHRSE) & '10-'17 Trikes	7059	\$199.99
	'07-'13 FLHTCUSE, '14 FLHTKSE & '11 FLTRUSE; Stock on '07-'13 FLHTCUSE, '14 FLHTKSE & '11 FLTRUSE & sold as an accessory as H-D P/N 50768-07.	4505	\$199.99
	'04-'05 FLHTCSE & '06 FLHTCUSE; Stock on '04-'05 FLHTCSE & '06 FLHTCUSE & sold as an accessory as H-D P/N 52714-04	4570	\$199.99
	A chrome version of the stock '93-'06 mount sold as Kuryakyn P/N's 4569 & 4536 or H-D P/N 53070-00.	7926	\$199.99
	'07-'09 Electra Glides (except '07-'09 FLHTCUSE), Road Glides (except '09 FLTRSE), Road Kings (except '07 FLHRS & '07-'08 FLHRSE) & Trikes	4571	\$199.99
	'93-'06 Electra Glides (except '04-'05 FLHTCSE, '06 FLHTCUSE), Road Glides, Road Kings (except '04-'06 FLHRS/l) & Tour Glides	7926	\$199.99

SPECIAL APPLICATIONS

If you have modified your motorcycle, the chart below will help you identify the correct product selection for trouble-free installation.

'93-'08 MODELS WITH RINEHART EXHAUST	PRICE
'07-'08 Electra Glides, Road Glides, Road Kings	7926, 4561, & 4569 \$369.97
'93-'06 Electra Glides, Road Glides, Road Kings	7926 & 4537 \$279.98
'93-'08 Electra Glides, Road Glides, Street Glides, Tour Glides & Road Kings with Chrome or Black H-D Passenger Floorboard Support Kits (H-D P/N 52714-04)	7926, 4561, & 4569 \$369.97
'04-'05 FLHTCSE & '06-'08 FLHTCUSE	7926, 4561, & 4569 \$369.97

PASSENGER PEGS: FIXED & ADJUSTABLE PEGS & FOOT CONTROLS



TO CREATE THE ULTIMATE TOURING MACHINE

Combine our Passenger Pegs with a set of Highway Cruise Pegs (pg 128), Saddleshields (pg 279), Passenger Armrests (pg 269), & Quick Adjust Tour-Pak® Relocator (pg 271).

PASSENGER BOARD MOUNTS FOR TOURING

Kuryakyn offers chrome standard length board mounts as well as black or chrome extended mounts for added comfort or to provide clearance when installing Adjustable Passenger Pegs with Rinehart Exhaust.

FOR HARLEY-DAVIDSON®

EXTENDED LENGTH

Fits: '93-'17 Electra Glides, Road Glides, Road Kings, Street Glides & Tour Glides

4561 Chrome (ea) \$99.99
Note: Extended length version primarily used for additional clearance when installing exhaust on '93-'08 models.

4537 Black (ea) \$79.99
Note: Extended length version primarily used for additional clearance when installing Adjustable Passenger Pegs with Rinehart exhaust on '93-'08 models.

STANDARD LENGTH

Fits: '93-'17 Electra Glides, Road Glides, Road Kings, Street Glides, Tour Glides & '09-'16 Trikes

4569 Chrome (ea) \$69.99

4536 Chrome (pr) \$129.99

Note: All mounts accept Kuryakyn Adjustable Passenger Pegs, P/N 7926.

REPLACEMENT COMPONENTS FOR ADJUSTABLE PASSENGER PEGS

Replacement Pin, Spring and Knob kit for Kuryakyn Adjustable Passenger Pegs.

FOR HARLEY-DAVIDSON®

4376 Replacement Tapered Peg Mount with Screw for 4352, 4353, 4388 & 4389 Fits: Kuryakyn P/N's 4352, 4353, 4388 & 4389 (ea) \$9.99

Fits: Kuryakyn Adjustable Passenger Pegs, P/N 4353 (Services both sides.)

4367 Pivot Shaft Service Kit for 4353 (ea) \$24.99

Fits: Kuryakyn Adjustable Passenger Pegs, P/N 4353 (Services one side.)

4368 Replacement Pin, Spring & Knob for 4353 (ea) \$9.99

Fits: Kuryakyn Adjustable Passenger Pegs, P/N's 4505, 4570, 4571 & 7926

7883 Pivot Shaft Service Kit for 4505, 4570, 4571 & 7926 (set) \$18.99

7882 Replacement Pin, Spring & Knob Kit for 4505, 4570, 4571 & 7926 (ea) \$9.99

Note: Services one side.

FOR HARLEY-DAVIDSON®

NEW

FEATURED BIKES

COLLECTIONS

Audio

Lighting

Accessory Mounts

Handlebar Controls, Grips & Mirrors

Pegs & Foot Controls

Covers, Trims & Accents

Air Cleaners

Crusher

Exhaust

Air Cleaners

Performance Components

Touring & Comfort

Windshields & Air Management

Luggage Organizers & Storage Covers

INDEX



PEGS & FOOT CONTROLS PASSENGER PEGS: FIXED & ADJUSTABLE



UNDERSEAT PEG MOUNTS FOR SOFTAIL

These Mounts will give your passenger that "breeze past the knees" chopper-style riding position. Great for also giving small passengers rides.

FOR HARLEY-DAVIDSON®

Fits: '08-'17 Softail Models, (except '08-'09 FXCW, '08-'11 FXCWC & '13-'17 FXSB), '06-'07 FXST Softail Standard, '06-'07 FXSTB Night Train, '07 FXSTC Softail Custom, '06 FXSTS Softail Springer, '07 FLSTF Fat Boy & '06 FLSTFSE Screamin' Eagle Fat Boy

4344 Chrome (pr) \$99.99

4334 Gloss Black (pr) \$99.99

Fits: '86-'07 Softail Models (except '00-'07 FXSTD, '06-'07 FXST/B/C/S, '06 FLSTFSE, '07 FLSTF)

7960 Chrome (pr) \$99.99



ADJUSTABLE PASSENGER PEG MOUNTS FOR TOURING

Direct replacements for stock passenger floorboards. Accepts any H-D style male mount peg and adjusts to any of the three stock positions.

FOR HARLEY-DAVIDSON®

Fits: '93-'17 Electra Glides, Road Glides, Road Kings, Street Glides, Tour Glides & '09-'17 Trikes

7527 Adjustable Passenger Peg Mounts (pr) \$99.99

2" OFFSET FOR PASSENGER BOARD MOUNTING

Just add boards!

MULTI-FIT

Fits: All Kuryakyn Floorboards for Mounting with Model Specific Splined Adapters (sold separately) 

8837 2" Offset for Passenger Board Mounting (pr) \$49.99

Note: Not intended for Driver Position Applications.

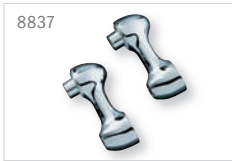

MALE MOUNT LOCKABLE OFFSET

Greater flexibility for a wide variety of applications without fear of slippage. Tapered end accepts Kuryakyn footpegs requiring tapered adapters (sold separately).

MULTI-FIT

Fits: Kuryakyn Footpegs Using Tapered Adapters for H-D Style Male Mount Applications & Typical Male Mount Cruise Peg Applications

7936 2" Lockable Offset (pr) \$69.99

7937 4" Lockable Offset (pr) \$69.99

Note: Not compatible with Kuryakyn Floorboards, Liberator Pegs or SwingWing Pegs or Kinetic Pegs.

FOOTPEG & FLOORBOARD RELOCATORS PEGS & FOOT CONTROLS

ADJUSTABLE LOCKABLE OFFSETS

Adjust your pegs 2" or 4" forward, back, up or down for perfect comfort. 360° of lockable adjustability. Kuryakyn Male Mount Pegs sold separately.

MULTI-FIT

Fits: H-D Style Male Mount Applications & Typical Male Mount Cruise Peg Applications

4557 4" Adjustable Lockable Offset with Male Mount Adapters (pr) \$99.99

4556 2" Adjustable Lockable Offset with Male Mount Adapters (pr) \$99.99

Fits: Direct Replacement for H-D Style Male Mount Footpegs. Universal Fitment for Footpegs with Male Mount Adapters for Typical Cruise Peg Applications

4559 4" Adjustable Lockable Offset without Male Mount (pr)  \$79.99

Note: Not recommended for use on mounts fastened to the motorcycle with only a single fastener. Leverage applied by the offset arm will cause the mount to twist and loosen from the motorcycle.

FLIP BLADES

These stealthy highway pegs bolt in place on the bottom of Traditional or Swept Wing H-D floorboards and fold out to lock in place. The hinged design eliminates cornering touch-downs, and release lever reverts the blades to original positioning.

FOR HARLEY-DAVIDSON®

FOR SWEEP WING BOARDS

Fits: '04-'05 FLHTCSE, '09 FLTRSE, '10-'13 & '15-'17 FLTRX/S, '12-'13 FLTRXSE, '04-'07 FLHRS/I, '07-'08 & '13-'14 FLHRSE, '06-'17 FLHX/I, '14-'17 FLHXS, '10-'12 FLHXSE, '10-'12 FLTSTSE, '14-'15 FLSTNSE or any H-D Model Equipped with H-D Swept Wing Shape Boards.

7541 Flip Blades (pr) \$199.99

7557 Reduced Reach Flip Blades (pr) \$199.99

FOR TRADITIONAL BOARDS

Fits: '84-'17 Electra Glide Classics and Standards (except '04-'05 FLHTCSE), '84-'96 Tour Glides, '98-'09 Road Glides (except '09 FLTRSE), '94-'17 Road Kings (except '04-'07 FLHRS, '07-'08 & '13-'14 FLHRSE), '10-'11 Street Glide Trike, '86-'08 FLST/FLSTC, '90-'17 FLSTF, '93-'96 FLSTN, '97-'03 FLSTS, '05-'07 FLSTSC, '12-'16 Dyna Switchback

7540 Flip Blades (pr) \$199.99

7556 Reduced Reach Flip Blades (pr) \$199.99

Note: Not recommended for use with fairing lowers.



MORE OPTIONS

ENGINE GUARDS PG 127

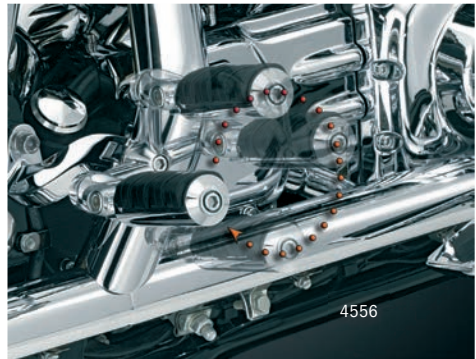
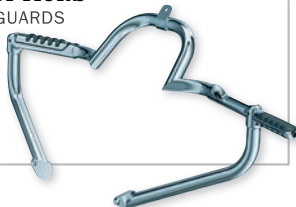

Adjust Your Pegs 2" or 4"

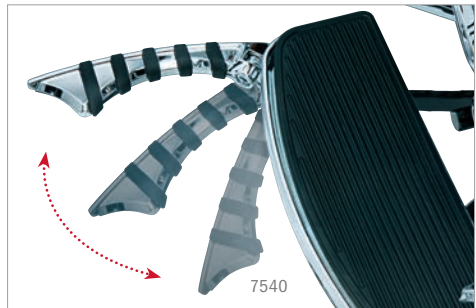

*Arms Fold Away Discreetly
When Not In Use*



FOR HARLEY-DAVIDSON®

NEW

FEATURED BIKES

COLLECTIONS

Audio

Lighting

Accessory Mounts

Handlebar Controls, Grips & Mirrors

Pegs & Foot Controls

Covers, Trims & Accents

Air Cleaners

Crusher

Exhaust

Air Cleaners

Performance Components

Touring & Comfort

Windshields & Air Management

Luggage Organizers & Storage Covers

INDEX



PEGS & FOOT CONTROLS HIGHWAY & CRUISE ARMS

7914

CRUISE ARM MARK III

Simply drill mounting holes in the steel floorboard base for the adjustable mount and full-length reinforcing plate. Reinforcing plate adds stiffness to the floorboard to keep flex to a minimum. The stock rubber floorboard pads remain unaffected. The arms are fully adjustable front to back. Accepts any H-D style male mount footpeg, sold separately.

FOR HARLEY-DAVIDSON®

4533 Cruise Arm Mark III (ea) \$51.99
Fits: Required for installation of P/N 7914 on '84-'08 Electra Glides, Road Glides, Road Kings & Tour Glides

7914 Cruise Arm Mark III (pr) \$179.99
Fits: '84-'17 Electra Glides (except FLHTCU, FLHTK, FLHTCSE, FLHTCUSE, FLHTKSE), '84-'91 FLTC Tour Glides, '98-'09 Road Glides (except '09 FLTRSE), '94-'17 Road Kings (except '04-'07 FLHRS, '07-'08 & '13-'14 FLHRSE), '10-'11 Street Glide Trikes; '86-'08 FLST/FLSTC, '90-'17 FLSTF, '93-'96 FLSTN, '97-'03 FLSTS & '05-'07 FLSTSC

Note: Only compatible with O.E.M. H-D floorboards. Adjustment is limited when installed on motorcycles with engine guards.



7841

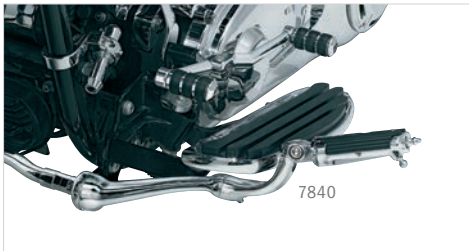

7840

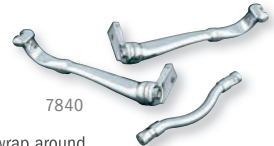

7840

CRUISE ARM MARK IV

Heavy-duty chrome arms wrap around your stock floorboards just right, so kick back and relax! No drilling required. Mounts directly to frame, not the board. Compatible with Kuryakyn ISO-Boards and all H-D footboards.

FOR HARLEY-DAVIDSON®

Fits: '00-'17 FL Softail Models Without Engine Guards (except '05-'06 FLSTFSE)

7840 Standard Length Cruise Arm Mark IV (set) \$199.99
Note: Adjustment on '07-'17 models is limited. Not compatible with oil coolers.

7841 Extended Length Cruise Arm Mark IV (set) \$199.99
Note: Not compatible with oil coolers.

Note: Adjustment of Standard Version is limited on '07-'17 Models. Not compatible with oil coolers or engine guards. Accepts any H-D style Male Mount Footpeg, sold separately.



7868

ADJUSTABLE MUSTACHE BAR FOR SPORTSTER

These super adjustable cruise pegs for Sportsters are quick and easy to install, and provide a wide range of adjustment. They bolt securely to the welded cross brace near the bottom of the downtubes and work on models with or without forward controls. Accepts any H-D style male-mount footpegs (sold separately).

FOR HARLEY-DAVIDSON®

7868 Fits: '04-'17 Sportster Models (ea) \$169.99

7869 Fits: Late-'84-'03 Sportster Models (ea) \$169.99

ENGINE GUARDS PEGS & FOOT CONTROLS



ERGO PLUS ENGINE GUARD

U.S. Patents D513,719; 6,969,083 & 7,073,808

This innovative design combines a stylish engine guard with built-in highway pegs.

FOR HARLEY-DAVIDSON®

CHROME

7529 Fits: '00-'17 FL Softail Models (ea) \$399.99

7532 Fits: '97-'17 Electra Glides, Road Kings & Street Glides (ea) \$399.99

GLOSS BLACK

7577 Fits: '00-'17 FL Softail Models (ea) \$399.99

7576 Fits: '97-'17 Electra Glides, Road Kings & Street Glides (ea) \$399.99

Note: P/N 7529 & 7577 include shortened replacement brake pedal.

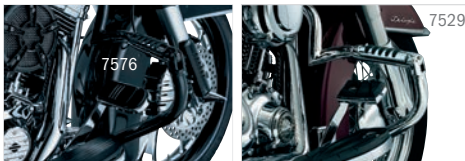
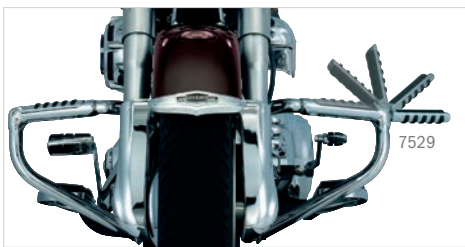

ADJUSTABLE MUSTACHE BAR

Our Mustache Bar has the ability to be adjusted to fit virtually any rider. Due to its cleverly designed clamp system, it can be moved up or down the downtubes and rotated to provide fore and aft adjustment. Accepts any typical male mount cruise pegs, sold separately.

FOR HARLEY-DAVIDSON®

7503 Fits: '91-'17 Dyna Models (ea) \$189.99

7502 Fits: '86-'17 Softail & Rocker Models (ea) \$189.99



FOR HARLEY-DAVIDSON®

NEW

FEATURED BIKES

COLLECTIONS

Audio

Lighting

Accessory Mounts

Handlebar Controls, Grips & Mirrors

Pegs & Foot Controls

Covers, Trims & Accents

Air Cleaners

Crusher

Exhaust

Air Cleaners

Performance Components

Touring & Comfort

Windshields & Air Management

Luggage Organizers & Storage Covers

INDEX



PEGS & FOOT CONTROLS HIGHWAY & CRUISE PEGS



MUST-HAVE



LONGHORN OFFSET HIGHWAY PEGS

The all-in-one answer for long-haul comfort. We combined our most popular highway peg components into one product that's attractive, adjustable and easy to install.

MULTI-FIT		
1-1/2" DIAMETER TUBING		
4574	Chrome - Dually ISO-Pegs (pr)	\$169.99
1-1/4" DIAMETER TUBING		
7599	Gloss Black - Trident Dually ISO-Pegs (pr)	\$169.99
4575	Chrome - Dually ISO-Pegs (pr)	\$169.99
4616	Chrome - SweptWing Pegs (pr)	\$169.99
7555	Chrome - Trident Dually ISO-Pegs (pr)	\$169.99



ENGINE GUARD OR FRAME MOUNT FOOTPEGS

With the trusted Magnum Quick Clamp, install on any round tubing. Keep in mind that the footpeg itself will end up perpendicular to the bar to which it is mounted.

MULTI-FIT		
1" DIAMETER TUBING		
8030	Small ISO-Pegs (pr)	\$99.99
8031	Large ISO-Pegs (pr)	\$103.99
1-1/4" DIAMETER TUBING		
4451	ISO-Wing Pegs (pr)	\$149.99
7992	Dually ISO-Pegs (pr)	\$139.99
4435	Pilot Pegs (pr)	\$129.99
8070	Small ISO-Pegs with ISO-Stirrups (pr)	\$169.99
8071	Large ISO-Pegs with ISO-Stirrups (pr)	\$169.99
8032	Small ISO-Pegs (pr)	\$99.99
8033	Large ISO-Pegs (pr)	\$103.99
4443	Switchblade Pegs (pr)	\$189.99



Note: If your engine guard is angled in such a way so that the peg will not be level once installed, see our Right Angle Mounts or P/N 8008A.

HIGHWAY & CRUISE PEGS PEGS & FOOT CONTROLS

Made Especially for Bikes with Lowers!

TOUR-TECH™ ADJUSTABLE CRUISE MOUNTS

FOR 1-1/4" ENGINE GUARDS

The entire assembly can be moved up or down on the engine guard. The arm and footpeg may be further adjusted along a vertical or horizontal arc. A unique clevis permits angle adjustment of the footpeg. The heavy-duty Quick Clamp and sturdy offset arm ensures that the footpegs will clear fairing lowers and will stay where you put them. Recommended for any model using 1-1/4" engine guards.

MULTI-FIT

LONG ARM FOR SHORT RIDERS (PEG MOUNTS 6" BACK FROM BAR)

Fits: 1-1/4" Engine Guards or Tubing

4529	Chrome - Dually ISO-Pegs (pr)	\$179.99
7586	Chrome - Trident Dually ISO-Pegs (pr)	\$179.99
7584	Gloss Black - Trident Dually ISO-Pegs (pr)	\$179.99
7582	Chrome - Premium Mini Boards (pr)	\$199.99
7598	Gloss Black - Premium Mini Boards (pr)	\$199.99
4528	Chrome - ISO-Wing Pegs (pr)	\$199.99
4526	Chrome - Mounts Only (pr)	\$109.99
7575	Gloss Black - Mounts Only (pr)	\$109.99

SHORT ARM FOR TALL RIDERS (PEG MOUNTS 4" BACK FROM BAR)

Fits: 1-1/4" Engine Guards or Tubing

4523	Chrome - Dually ISO-Pegs (pr)	\$179.99
7585	Chrome - Trident Dually ISO-Pegs (pr)	\$179.99
7583	Gloss Black - Trident Dually ISO-Pegs (pr)	\$179.99
7580	Chrome - Premium Mini Boards (pr)	\$199.99
7581	Gloss Black - Premium Mini Boards (pr)	\$199.99
4522	Chrome - ISO-Wing Pegs (pr)	\$199.99
4520	Chrome - Mounts Only (pr)	\$109.99
7574	Gloss Black - Mounts Only (pr)	\$109.99

OFFSET HIGHWAY PEGS

The clamp can be positioned forward or back, and the arm offers full 360-degree rotation for tall, short, or in-between riders! If your engine guard is angled in such a way that the peg will not be level once installed, find our Right Angle Mounts or Male Adapters with Adjustable Stop. (Peg mounts perpendicular to engine guard.)

MULTI-FIT

Fits: 1-1/4" Engine Guards or Tubing

7993	Dually ISO-Pegs (pr)	\$149.99
4436	Pilot Pegs (pr)	\$149.99
7998	Small ISO-Pegs (pr)	\$129.99
7999	Large ISO-Pegs (pr)	\$139.99



FOR HARLEY-DAVIDSON®

NEW

FEATURED BIKES

COLLECTIONS

Audio

Lighting

Accessory Mounts

Handlebar Controls, Grips & Mirrors

Pegs & Foot Controls

Covers, Trims & Accents

Air Cleaners

Crusher

Exhaust

Air Cleaners

Performance Components

Touring & Comfort

Windshields & Air Management

Luggage Organizers & Storage Covers

INDEX



PEGS & FOOT CONTROLS HIGHWAY & CRUISE PEGS



4515



4501



4511

4503



7559

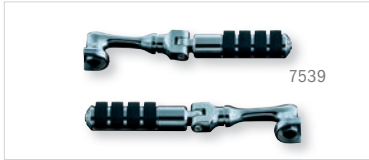

7539



4514



7944



7572

X-TENSION CRUISE PEG MOUNTS

Measuring 4-1/2" long with a 1-1/4" offset, the rider may now increase or decrease the reach to the highway peg. P/N 4501 provides a full setup and includes 1-1/4" Magnum Quick Clamps, X-Tension, 2-1/2" Peg Extensions and Dually Pegs for a full kit. The X-Tension mounts with Magnum Quick Clamps and will accept any typical male mount cruise peg applications.

MULTI-FIT

4515 X-Tension Cruise Peg Mount (pr) \$83.99
 Fits: Mounts with a 1/2"-13 Bolt. May be Used with OEM Highway Peg Mounts, Some Forward Control Plates or with Magnum Quick Clamps.

4501 X-Tension Cruise Peg Mount with Dually ISO-Pegs (pr) \$199.99
 Fits: Universal Applications with 1-1/4" Tubing

Note: Not suggested for use with full size engine guards.

RIGHT ANGLE CRUISE MOUNTS & PEGS

Allows you to position the peg horizontally regardless of the orientation of the engine guard or frame tube. Typical for mounting on front down tubes or engine guards.

MULTI-FIT

MOUNTS ONLY

Fits: Universal Applications, Requires Magnum Quick Clamps & Male Mount Cruise Pegs, Sold Separately.

4503 Long Mounts Only, 4-1/2" Long (pr) \$49.99

4511 Short Mounts Only, 3-3/4" Long (pr) \$49.99

MOUNTS WITH PEGS

Fits: Universal Applications, Requires Magnum Quick Clamp, Sold Separately

7539 Long Mounts - Longhorn ISO-Pegs (pr) \$99.99

MOUNTS WITH PEGS & CLAMPS

Fits: 1-1/4" Engine Guards or Tubing

4517 Short Mounts - Small ISO-Pegs - 1-1/4" (pr) \$129.99

4514 Short Mounts - Dually ISO-Pegs - 1-1/4" (pr) \$139.99

Fits: Universal Applications for 1-1/2" Tubing.

7559 Long Mounts - Trident ISO-Pegs - 1-1/2" (pr) \$159.99

PEG MOUNTS WITH MAGNUM™ QUICK CLAMPS

This setup allows the use of any Kuryakyn cruise peg-style male mount or H-D style male-mount pegs with our innovative Magnum Quick Clamps and Clevises for engine guard applications.

MULTI-FIT

Fits: 1-1/2" Engine Guards or Tubing

4573 Chrome (pr) \$79.99

Fits: 1-1/4" Engine Guards or Tubing

7944 Chrome (pr) \$79.99

7572 Gloss Black (pr) \$79.99

Note: Requires male mount pegs, sold separately.

HIGHWAY & CRUISE PEGS PEGS & FOOT CONTROLS

BRUTE HIGHWAY PEG MOUNTS

The slim design and smooth contours make a great fit for any motorcycle with 1-1/4" engine guards, including Touring models with fairing lowers. The fasteners securing the clamps to the engine guard face inward, providing a clean look not found in other designs.

MULTI-FIT

Fits: 1-1/4" Engine Guards or Tubing

7617	Chrome (pr)	\$79.99
7616	Gloss Black (pr)	\$79.99



TECH TIP

Check bolts/hardware for all newly installed items after the first 100-200 miles for tightness and secure fitment

PEG MOUNTS & MOUNTING CLEVISSES

All footpeg mounting clevises and footpeg mounts listed perform a similar function. Your decision will be determined by the length required and the style you prefer.

MULTI-FIT

8088	Chrome - 3-1/2" Peg Mount with 1/2"-13 Mount Bolts (pr)	\$39.99
8087	Chrome - 3-1/2" Peg Mount with 3/8"-16 Mount Bolts (pr)	\$39.99
4568	Chrome - Serrated Replacement Clevis with Hardware (ea)	\$21.99
7996	Chrome - Offset Peg Mounts with 1/2"-13 Mounting Bolt (pr)	\$59.99
8016	Chrome - Longhorn Offset Peg Mounts (pr) Fits: Universal Applications, Requires Magnum Quick Clamps & Male Mount Pegs, Sold Separately	\$79.99
8061	Chrome - Short Magnum Peg Mount with 1/2"-13 Mounting Bolt (pr)	\$32.99
7573	Gloss Black - Short Magnum Peg Mount with 1/2"-13 Mounting Bolt (pr) Fits: Universal Fitment using 1/2"-13 Mounting Bolt for Any H-D Style Male Mount Peg	\$32.99
8015	Chrome - Peg Mount Clevises with 1/2"-20 Mount Bolts (pr)	\$19.99

Note: To measure your tube size tighten an adjustable wrench around the tube. Remove the wrench & measure the opening. Mounting Cruise Pegs off frame tubes requires 1-1/2" of straight unobstructed tubing for clamping at equal height on both sides & approximately 3/8" of clearance around tube.



TECH TIP

Adequately tighten all fasteners during installation and use medium strength thread lock where applicable.



7617



7616



7617

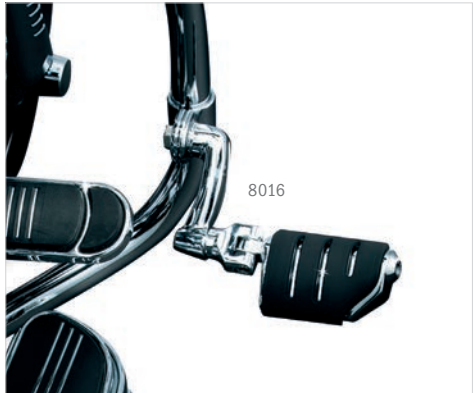

8016

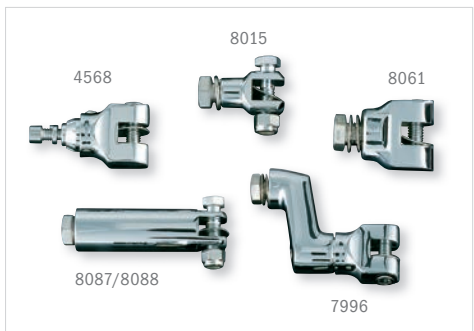

8015

4568

8061

8087/8088

7996



7573

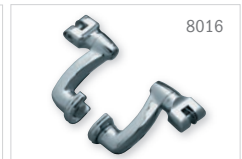

8016

FOR HARLEY-DAVIDSON®

NEW

FEATURED BIKES

COLLECTIONS

Audio

Lighting

Accessory Mounts

Handlebar Controls, Grips & Mirrors

Pegs & Foot Controls

Covers, Trims & Accents

Air Cleaners

Crusher

Exhaust
Air Cleaners
Performance Components

Touring & Comfort

Windshields & Air Management

Luggage Organizers & Storage Covers

INDEX



PEGS & FOOT CONTROLS CLAMPS & MOUNTS

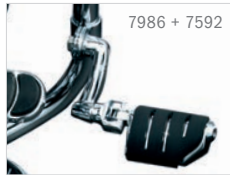
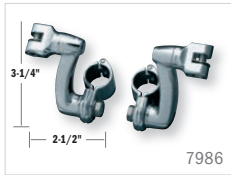

TECH TIP
Use blue threadlocker on all footpeg fasteners upon install

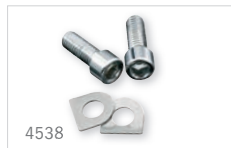

REPLACEMENT SCREWS & D-WASHERS

These screws and D-Washers can be used to replace lost or damaged pieces in any of our Magnum-style peg mounts. These mounts are found in virtually all of our highway peg assemblies.

MULTI-FIT

4508	D-Washers (pr) Fits: Replacement D-Washers	\$2.99
4538	Replacement Clevis Screws with D-Washers (set) Fits: Replaces Peg Fastener On Kuryakyn Magnum Footpeg Mounts	\$5.99



KOOL KAPS CHROME BOLT COVERS

Easily installs over the head of your existing bolts.

MULTI-FIT

2451	Fits: 1/2" Hex Head (Uses 3/4" Wrench) (pr)	\$2.99
------	---	--------

LONGHORN OFFSET PEG MOUNTS WITH MAGNUM™ QUICK CLAMPS

Its 3-1/4" radius gives an incredible 6-1/2" range of adjustment. Its gently curved shape keeps the peg tucked in toward the center line of the bike for maximum comfort. Guaranteed not to slip.

MULTI-FIT

4577	Chrome Longhorn Offset Mounts with 1-1/2" Magnum Quick Clamp (pr)	\$119.99
7986	Chrome Longhorn Offset Mounts with 1-1/4" Magnum Quick Clamps (set)	\$119.99
7571	Gloss Black Longhorn Offset Mounts with 1-1/4" Magnum Quick Clamp (set)	\$119.99

Note: Requires male mount footpegs (sold separately).

MAGNUM™ QUICK CLAMPS

Stainless steel construction for superior strength, and hinged construction for fast, simple installation. No more stripped bolt heads common of 3-piece designs. Accepts a 1/2" clamp bolt.

MULTI-FIT

7940	Chrome - 1" (ea)	\$24.99
1002	Chrome - 1" (pr)	\$45.99
1001	Chrome - 1-1/2" (pr)	\$45.99
8073	Chrome - 1-1/4" (ea)	\$23.99
1000	Chrome - 1-1/4" (pr)	\$45.99
1003	Gloss Black - 1-1/4" (ea)	\$23.99
7942	Chrome - 1.35" (ea)	\$24.99
7941	Chrome - 1-1/8" (ea)	\$24.99

SHIFT LINKAGES & ARM COVERS PEGS & FOOT CONTROLS



BAHN™ SHIFT ARM FOR TOURING & TRIKE

Not just a cover, this is a complete high-quality forged and machined aluminum arm engineered with a precision fit to replace the boring stock shift arm.

FOR HARLEY-DAVIDSON®

Fits: '84-'16 Electra Glides, Road Glides, Road Kings, Street Glides, Tour Glides & '09-'16 Trikes

9696	Chrome (ea)	\$99.99
1096	Tuxedo (ea)	\$99.99



FLAME™ SHIFT ARM COVER

Attention Pyromaniacs: Light up your shift arm with this easy-to-install cover. Looks great by itself, but things really get blazing when used with our Flame Shift Linkage (P/N 1072).

FOR HARLEY-DAVIDSON®

1059	Flame Shift Arm Cover (ea)	\$49.99
Fits: '82-'16 Electra Glides, Road Glides, Road Kings, Street Glides, Tour Glides & '09-'16 Trikes		

1082	Flame Shift Arm Cover (ea)	\$49.99
Fits: All '07-'17 Softail Models		



ZOMBIE™ SHIFT ARM COVER

Detail; the difference between the unremarkable and the distinctive. The Zombie Shift Arm Cover, whether used alone or as an addition to other members of this popular collection, provides a distinctive touch sure to be caught by those with a discerning eye.

FOR HARLEY-DAVIDSON®

1054	Zombie Shift Arm Cover (ea)	\$49.99
Fits: '82-'16 Electra Glides, Road Glides, Road Kings, Street Glides, Tour Glides & '09-'16 Trikes		

1081	Zombie Shift Arm Cover (ea)	\$49.99
Fits: All '07-'17 Softail Models		

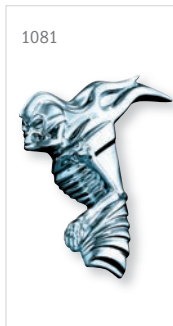

TRANSMISSION SHIFT ARM COVER

Simply bolt on and rid yourself of a dull, stock arm.

FOR HARLEY-DAVIDSON®

Fits: '01-'16 Electra Glides, Road Glides, Road Kings, Street Glides; '09-'16 Trikes, '01-'17 Softails & '01-'17 Dynas

1068	Transmission Shift Arm Cover (ea)	\$19.99
------	-----------------------------------	---------

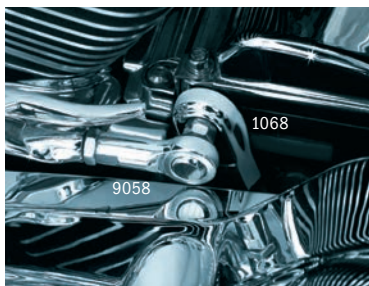

CHROME UNIVERSAL JOINTS

Universal chrome joints for shift linkages.

FOR HARLEY-DAVIDSON®

Fits: 5/16"-24 R.H. Threads

9046	Ball Joint Style with Short Stud, R.H. Female Threads (ea)	\$20.99
------	--	---------

Fits: Barrel Style, 5/16"-24 R.H. Female Threads (ea)

9056	Barrel Style, R.H. Female Threads (ea)	\$20.99
9058	Ball Joint Style, R.H. Female Threads (ea)	\$29.99



FOR HARLEY-DAVIDSON®

NEW

FEATURED BIKES

COLLECTIONS

Audio

Lighting

Accessory Mounts

Handlebar Controls, Grips & Mirrors

Pegs & Foot Controls

Covers, Trims & Accents

Air Cleaners

Crusher

Exhaust

Air Cleaners

Performance Components

Touring & Comfort

Windshields & Air Management

Luggage Organizers & Storage Covers

INDEX



PEGS & FOOT CONTROLS SHIFT LINKAGES & ARM COVERS

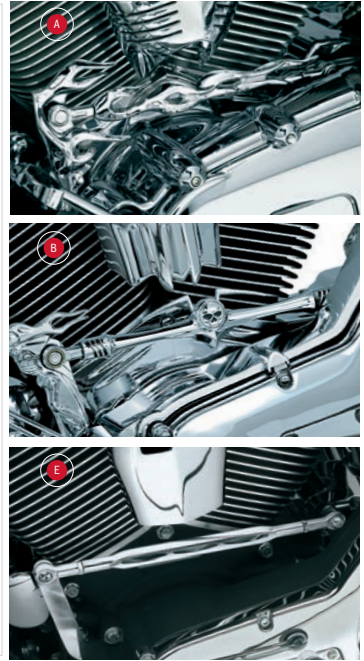
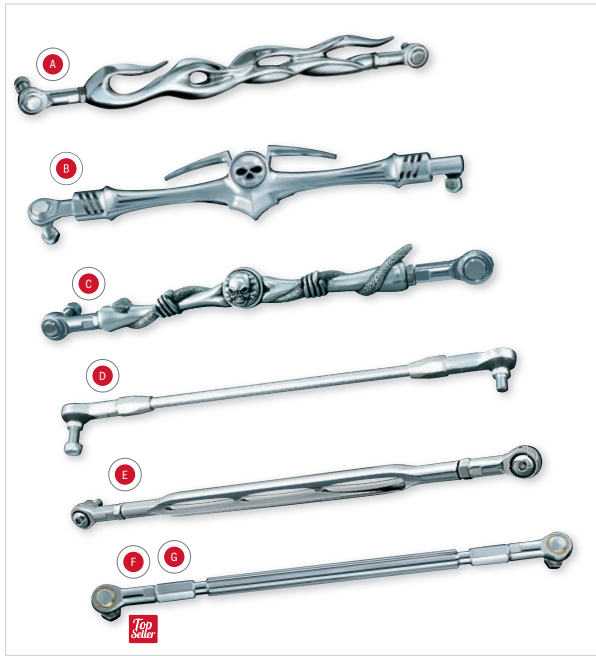



SHIFT LINKAGES

Fits: '80-'17 Electra Glides, Road Glides, Road Kings, Street Glides & Tour Glides; '09-'17 Trikes & '86-'17 Softail Models (except '97-'99 FLSTS)

Note: Can also be used on '93-'16 Dyna Models with forward controls if Shift Linkage Extension Kit (P/N 1067) is added, sold separately.

A	1072	Flame Shift Linkage (ea)	\$119.99
B	1075	Zombie Shift Linkage (ea)	\$109.99
C	1079	Serpent Shift Linkage (ea) See page 135 to customize your Serpent shift linkage with themed emblems.	\$99.99
D	1077	Chrome Shift Linkage (ea)	\$59.99

Fits: '80-'17 Electra Glides, Road Glides, Road Kings, Street Glides & Tour Glides; '09-'17 Trikes; '86-'17 Softail Models (except '97-'99 FLSTS) & '93-'02 Dyna Wide Glides

E	9054	Girder Shift Linkage (ea)	\$109.99
F	9059	Custom Extruded Shift Linkage (ea)*	Includes red, blue & chrome lock nuts  \$79.99
G	1063	Extended Extruded Shift Linkage (ea)* Custom Applications - Adjusts from 15" to 15-1/2"	Includes red, blue & chrome lock nuts  \$79.99

* Also fits '93-'05 Dyna Wide Glides

SHIFT LINKAGES & ARM COVERS PEGS & FOOT CONTROLS



BAHN™ SHIFT LINKAGE COVER FOR TOURING & TRIKE

Completely blanket that boring stock shift linkage rod and ball joints with this refined forged aluminum cover. Machined for a hassle-free precision fit.

FOR HARLEY-DAVIDSON™

Fits: '99-'17 Electra Glides (except '04-'05 FLHTCSE, '06-'13 FLHTCUSE & '14-'17 FLHTKSE), Road Glides (except '11 & '15-'17 FLTRUSE & '12-'13 FLTRXSE), Road Kings (except '02-'03, '07-'08 & '13-'14 FLHRSE), Street Glides (except '10-'12 & '15-'17 FLHXSE) & '09-'17 Trikes

7197	Chrome (ea)	\$139.99
1097	Tuxedo (ea)	\$139.99



SERPENT™ SHIFT LINKAGE EMBLEMS

Customize your Serpent Shift Linkage with these emblems.

FOR HARLEY-DAVIDSON™

Fits: Universal applications with 1" diameter flat surface, Serpent Shift Linkage (P/N 1079), Zombie Levers (P/N's 1047, 1058, 1060, 1090, 1091 & 1092) or Fender Tip Lens Grills (P/N's 8606, 8607 & 8608)

1083	Wild Boar Emblem (ea)	\$8.99
1084	Dollar Sign Bling Emblem (ea)	\$8.99
1085	Eagle Emblem (ea)	\$8.99
1086	Rose Emblem (ea)	\$8.99
1088	Ace of Spades Emblem (ea)	\$8.99
1089	Skull Emblem (ea)	\$8.99



SHIFTER SPLINE COVER

Removing the heel shift lever is an easy task, but it leaves the unsightly shifter spline exposed. Our slick little chrome cover solves that problem quickly and inexpensively.

FOR HARLEY-DAVIDSON™

Fits: All H-D Shifter Shafts

9072	Shifter Spline Cover, 1/2" I.D. (ea)	\$12.99
------	--------------------------------------	---------



SHIFT LINKAGE EXTENSION KIT

Now you can install any of our linkages or almost any standard shift linkage on bikes equipped with extended controls. The kit includes 1-1/2" and 2-1/2" extension adapters, which can be used independently or threaded together for up to 4" of extension.

FOR HARLEY-DAVIDSON™

Fits: Can be used to extend any shift linkage with 5/16"-24 right-hand threaded ends.

1067	Shift Linkage Extension Kit (kit)	\$19.99
------	-----------------------------------	---------



FOR HARLEY-DAVIDSON®

NEW

FEATURED BIKES

COLLECTIONS

Audio

Lighting

Accessory Mounts

Handlebar Controls, Grips & Mirrors

Pegs & Foot Controls

Covers, Trims & Accents

Air Cleaners

Crusher

Exhaust

Air Cleaners

Performance Components

Touring & Comfort

Windshields & Air Management

Luggage Organizers & Storage Covers

INDEX



PEGS & FOOT CONTROLS SHIFT & BRAKE LEVERS



HEEL SHIFT LEVER ELIMINATOR

Quickly and easily remove the heel shift lever on Dressers, Road Kings, or any FL Softail Models. Unique design keeps the shift shaft in perfect alignment to avoid premature shaft wear, a problem common to similar products. The Delrin® lining eliminates rattles and keeps your bike shifting as smoothly as ever.

FOR HARLEY-DAVIDSON®

1045	Heel Shift Lever Eliminator for Touring and Trike Fits: '80-'17 Electra Glides, Road Glides, Road Kings, Street Glides, Tour Glides & Trikes	\$34.99
1046	Heel Shift Lever Eliminator for FL Softail Fits: All '86-'17 FL Softail Models	\$34.99



1046



1045

EXTENDED GIRDER SHIFT LEVER

Gain additional room on the floorboard. 1-3/4" longer than stock. Works as both front or rear on floorboard-equipped Harleys. The perfect complement to our Extended Girder Brake Pedal.

FOR HARLEY-DAVIDSON®

Fits: Heel or Toe on '83-'17 Electra Glides, '98-'17 Road Glides (except '15-'17 FLTRUSE), '94-'17 Road Kings, '06-'17 Street Glides (except '15-'17 FLHXSE), '83-'96 Tour Glides, '09-'17 Tri Glides, '15-'17 Freewheelers & all '86-'17 FL Softail Models

1026	Extended Girder Shift Lever (ea)	\$79.99
------	----------------------------------	---------



1026

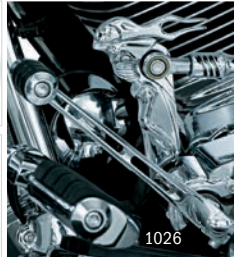

1065



1065



1066

SLOTTED SHIFT LEVER

Accepts any Kuryakyn or H-D shift peg (sold separately).

FOR HARLEY-DAVIDSON®

Fits: '83-'17 Electra Glides, Road Glides, Road Kings, Street Glides, Tour Glides, '09-'17 Trikes & '86-'17 FL Softail Models

1065	Slotted Shift Lever (ea)	\$69.99
------	--------------------------	---------



1066

LIBERATOR™ SHIFT LEVER

Accepts any Kuryakyn or H-D shift peg (sold separately).

FOR HARLEY-DAVIDSON®

Fits: '83-'17 Electra Glides, Road Glides, Road Kings, Street Glides, Tour Glides, '09-'17 Trikes & '86-'17 FL Softail Models

1066	Liberator Shift Lever (ea)	\$69.99
------	----------------------------	---------



1066



TECH TIP

Check bolts/hardware for all newly installed items after the first 100-200 miles for tightness and secure fitment

SHIFT & BRAKE LEVERS PEGS & FOOT CONTROLS

BAHN™ SHIFT LEVER

Shift your bike into style with this precision-machined forged aluminum Shift Lever and Peg. Measures 3/4" longer than stock, includes matching Shift Peg, and can be used for toe only, or heel-toe configurations.

FOR HARLEY-DAVIDSON®

Fits: Heel or Toe on '83-'17 Electra Glides, Road Glides, Road Kings, Street Glides, Tour Glides, '09-'17 Trikes & '86-'17 FL Softail Models

9695	Chrome (ea)	\$139.99
1095	Tuxedo (ea)	\$139.99



EXTENDED BRAKE PEDALS

Levers relocate the brake pedal pad while flattening the angle of the pad, resulting in easier and more natural braking. Amount of extension varies depending on application. All levers are beautifully polished and chrome-plated or powder-coated steel and feature a bronze bushing with a grease fitting for smooth operation and long life.

FOR HARLEY-DAVIDSON®

'14-'17 TOURING & TRIKE WITHOUT LOWERS

Fits: Following Models Without Fairing Lower: '14-'17 Electra Glides, Road Glides, Road Kings, Street Glides & Trikes

9670	Chrome (ea)*	\$99.99
9671	Gloss Black (ea)*	\$99.99

'14-'17 TOURING & TRIKE WITH LOWERS

Fits: Following Models With Fairing Lower: '14-'17 Electra Glides, Road Glides, Road Kings, Street Glides & Trikes

9672	Chrome (ea)*	\$99.99
9673	Gloss Black (ea)*	\$99.99

'08-'13 TOURING & TRIKE

Fits: '08-'13 Electra Glides, Road Glides, Road Kings, Street Glides & '09-'13 Trikes

1071	Chrome Girder (ea)	\$99.99
------	--------------------	---------

'97-'07 TOURING & '87-'17 FL SOFTAIL

Fits: '97-'07 Electra Glides, Road Glides, Road Kings & Street Glides; '87-'17 FL Softail Models

Note: On '02-'07 Models our extended Brake Pedals provide slightly more extension than stock but the Brake Pedal Pad is lower & flatter, making the transition from board to brake more neutral.

9061	Chrome(ea)	\$89.99
1027	Chrome Girder (ea)	\$99.99

Note: On '02-'13 Touring and FL Softail Models our Extended Brake Pedals provide just slightly more extension than stock but the brake pedal pad is lower & flatter, making the transition from board to brake more natural.

* Note: Not compatible with Kuryakyn Ergo Guards.

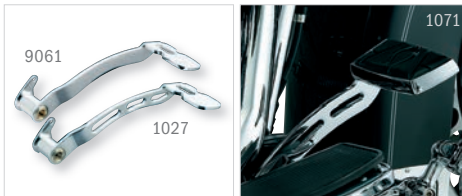
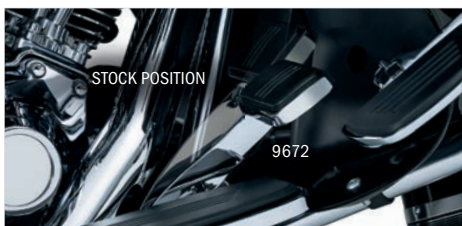

FOR HARLEY-DAVIDSON®

NEW

FEATURED BIKES

COLLECTIONS

Audio

Lighting

Accessory Mounts

Handlebar Controls, Grips & Mirrors

Pegs & Foot Controls

Covers, Trims & Accents

Air Cleaners

Crusher

Exhaust

Air Cleaners

Performance Components

Touring & Comfort

Windshields & Air Management

Luggage Organizers & Storage Covers

INDEX



MORE OPTIONS

PREMIUM BRAKE PEDAL PADS
PG 109-111



▶ WATCH THE VIDEO ONLINE!

PEGS & FOOT CONTROLS SHIFT & BRAKE LEVERS



GIRDER EXTENDED BRAKE PEDALS FOR '14-'17 TOURING AND TRIKE MODELS

Girder Extended Brake Pedals for models without fairing lowers are noticeably longer than stock, with a pad angle set lower and flatter for more comfortable rider operation. Girder Extended Brake Pedals for models with fairing lowers are the same length as stock to avoid interference, but also feature a more neutral pad location for better positioning, making it easier for the operator to engage. Made from quality steel, bronze pivot bushings with grease fitting ensure smooth operation and long life. Accepts stock or aftermarket brake pads designed for the stock pedal.

FOR HARLEY-DAVIDSON®

Fits: Following Models With Fairing Lower: '14-'17 Electra Glides, Road Glides, Road Kings, Street Glides & Trikes

MODELS WITH FAIRING LOWERS

Fits: Following Models With Fairing Lower: '14-'17 Electra Glides, Road Glides, Road Kings, Street Glides & Trikes

9648	Chrome (ea)	\$119.99
9649	Gloss Black (ea)	\$119.99



MODELS WITHOUT FAIRING LOWERS

Fits: Following Models Without Fairing Lower: '14-'17 Electra Glides, Road Glides, Road Kings, Street Glides & Trikes

9642	Chrome (ea)	\$119.99
9643	Gloss Black (ea)	\$119.99



Note: Not compatible with Kuryakyn Ergo Guards.



FORWARD CONTROLS FOR DYNA

Forward controls made simple. Flush, countersunk fasteners used for a clean, uncluttered appearance. All ball joints, linkages and visible hardware are chrome finished. Igus shifter bearings provide smooth, maintenance-free operation. These controls offer outstanding good looks, are user-friendly, and provide excellent value in a moderate price range. Footpegs not included.

FOR HARLEY-DAVIDSON®

Fits: '91-'17 Dyna Models (except '12-'16 FLD Dyna Switchback)

9063	Standard Forward Controls (ea)	\$399.99
9064	Extended Forward Controls (ea)	\$399.99

Note: Not compatible with most engine guards or with stock exhaust on '08-'17 FXDF, '09-'10 FXDFSE, '10-'17 FXDWG or '14-'17 FXDL. As a guideline, we suggest the Standard Controls, P/N 9063, for riders with a 33" or shorter inseam.



3" EXTENSION KIT FOR DYNA MODELS WITH FORWARD CONTROLS

Welcome relief for tall Dyna Wide Glide riders. Move your stock forward controls a full 3" forward. The set includes extension plates, countersunk trim plates, linkages, and all hardware. All chrome components. Only basic hand tools are needed to complete this easy installation.

FOR HARLEY-DAVIDSON®

9049	Fits: '03-'08 FXDWG & Any Dyna Models Using H-D Forward Controls (P/N 49080-03 or 49080-06) (set)	\$199.99
9062	Fits: '93-'02 FXDWG and any Dyna Models using H-D Forward Controls (P/N 49080-93A) (set)	\$199.99

Note: Also compatible with '08-'17 FXDF, '09-'10 FXDFSE or '10-'17 FXDWG if stock exhaust has been removed & replaced with a staggered dual system.